

deconta GmbH  
Im Geer 20  
46419 Isselburg

**deconta**



# Original instruction manual

**deco mobil C ECO 3000**

**deco mobil C 4000**

**deco mobil C 5000**

This user manual should be kept with the decontamination unit at all times.

A copy of this user manual will be supplied to the user when the unit is either purchased or when the unit is on hire.

## Revision index

Date	Version	Chapter	Reason	In-charge
01.09.2017	V2.0	All	Correction	deconta GmbH Im Geer 20 46419 Isselburg E-Mail: <a href="mailto:info@deconta.com">info@deconta.com</a>
17.07.2017	V0.0	All	New publication	uttc – Ingenieurgesellschaft mbH Friedrich-Heinrich-Allee 159 47475 Kamp-Lintfort Deutschland E-Mail: <a href="mailto:uttc@uttc.de">uttc@uttc.de</a> Order 2017-2139

This instruction manual has been created by us using our manufacturing and technical knowledge. If you discover an error or find the instructions ambiguous we would kindly ask that you inform us about the same, we would appreciate customer feedback as this helps improve our overall customer satisfaction. Please get in touch with:

deconta GmbH

Im Geer 20

46419 Isselburg

Tel.: 028749156-0

Fax: 028749156-11

E-Mail: [info@deconta.com](mailto:info@deconta.com)

Internet: [www.deconta.eu](http://www.deconta.eu)

## Ownership

This instruction manual is owned by:


deconta GmbH  
Im Geer 20  
46419 Isselburg

Version V2.0

© 2017

Reproduction, transmission or disclosure of the contents of this instruction manual are not permitted without express permission from deconta GmbH. Infringements of this copyright could lead to a claim for compensation. All rights reserved in the event of granting a patent or registration of a utility model.

## Table of contents

<b>1</b>	<b>Instructions on reading .....</b>	<b>6</b>
1.1	Abbreviations, synonyms, signs .....	6
1.2	Safety-related information .....	6
1.3	Non-company documents.....	7
1.4	Damage to property.....	7
<b>2</b>	<b>Legal regulations .....</b>	<b>8</b>
2.1	Exclusion of liability .....	8
2.2	Modifications.....	8
2.3	Existing directives.....	8
2.4	Sale in the non-European economic area.....	8
<b>3</b>	<b> Safety .....</b>	<b>9</b>
3.1	Intended use .....	9
3.2	Technical data .....	11
3.3	Maschine .....	13
3.3.1	Emergency stop, emergency shutdown system, main switch.....	13
3.3.2	Regular inspection of safety equipment .....	13
3.3.3	Protective conductor, earthing and equipotential bonding .....	14
3.3.4	Labels on the machine .....	14
3.4	Safety instructions .....	15
3.4.1	According to the source of the hazard.....	15
3.4.2	After the operation phase .....	17
3.5	Operator.....	20
3.5.1	Operation of the machine .....	20
3.5.2	Action during accidents .....	20
3.6	Staff .....	20
3.6.1	Description of the user groups .....	20
3.6.2	Restricted access .....	22
3.6.3	Personal protective equipment - PPE .....	23
<b>4</b>	<b>Machine description .....</b>	<b>24</b>
4.1	Scope of delivery .....	25
4.2	Structure .....	25
4.2.1	Structure of the deco mobil C ECO 3000 .....	25
4.2.2	Structure of deco mobil C 4000 .....	26
4.2.3	Structure of deco mobil C 5000 .....	27
4.2.4	Options of deco mobil C .....	28
4.3	Supply of energy and operating materials.....	29
4.3.1	Electrical .....	31
4.3.2	Pneumatics .....	31
4.3.3	Water .....	32
4.3.4	Fuel.....	32
4.4	Operating and indicating elements.....	33
4.4.1	Shower and vacuum cleaner push-buttons .....	33
4.4.2	Ballcock .....	35
4.4.3	Emergency shutdown switch.....	37
4.5	Workstations.....	38

## Table of contents

---

4.6	Function .....	38
<b>5</b>	<b>Transport .....</b>	<b>39</b>
5.1	Operation on road.....	39
5.1.1	General description of the trailer .....	39
5.1.2	Checks prior to any journey.....	40
5.1.3	Regular inspections and maintenance .....	41
<b>6</b>	<b>Assembly .....</b>	<b>49</b>
6.1	Requirements for assembly.....	49
6.2	Alignment and mounting.....	49
6.2.1	Crank supports deco mobil C 4000 / 5000 .....	49
6.2.2	Crank supports deco mobil C ECO 3000 .....	50
6.2.3	Entry aids.....	50
6.3	Check.....	50
<b>7</b>	<b>Commissioning .....</b>	<b>51</b>
7.1	Prior commissioning .....	51
7.2	Power on.....	51
7.3	Inspections .....	51
7.3.1	Inspection of safety equipment.....	51
7.3.2	Checking the function .....	51
7.4	Commissioning .....	52
<b>8</b>	<b>Operation and control.....</b>	<b>53</b>
8.1	Operating modes .....	53
8.1.1	Automatic mode.....	53
8.2	Controller .....	53
8.2.1	Functions of the programmable logic smart touch control A-version (autarkic).....	53
8.2.2	Functions of the programmable logic smart touch control E-version (electric).....	69
8.2.3	Communication module (Option).....	84
8.3	Control .....	102
8.3.1	Power on and Power off .....	102
8.4	Other options .....	103
8.4.1	Connection of all chambers to the sewage water filtration system ....	103
8.4.2	Compressed air system for respirators .....	104
8.4.3	Switchable socket and hose connection for vacuum cleaner (ATTIX 30)105	
<b>9</b>	<b>Faults .....</b>	<b>107</b>
9.1	Fault reports on the operating display .....	107
9.2	Faults without fault reports .....	107
<b>10</b>	<b>Maintenance .....</b>	<b>108</b>
10.1	Maintenance plan .....	108
10.1.1	Filter change sewage filter.....	108
10.1.2	Filter change HEPA-Filter.....	110
10.1.3	Sterilisation program.....	113
10.1.4	Shower hose.....	113
10.2	Repair .....	113

## Table of contents

---

10.3	Safety-related components.....	113
10.4	Inspections .....	113
<b>11</b>	<b>Decommissioning and Disassembly.....</b>	<b>114</b>
11.1	Decommissioning .....	114
11.2	Disassembly and Storage.....	114
11.2.1	Prepare machine and components .....	114
11.2.2	Storage .....	115
11.2.3	Inspect stored goods .....	115
11.3	Re-commissioning .....	115
11.4	Disassembly and disposal.....	116
<b>12</b>	<b>Attachments .....</b>	<b>117</b>
12.1	Non-company documentation .....	117
12.2	Own documentation.....	117
12.3	Suppliers of special tools, materials, professional help.....	118
12.4	Operating time in battery power .....	119
12.5	Identification plate.....	121
12.6	Declaration of conformity.....	123

## 1 Instructions on reading

### 1.1 Abbreviations, synonyms, signs

Abbreviation/ Synonym	Meaning
PSA	Personal protective equipment (PPE)
EMV	Electromagnetic compatibility (EMC)
BetrSichV	Ordinance on Industrial Safety and Health
DGUV	German Social Accident Insurance
Maschine	deco mobil C ECO 3000, C 4000, C 5000

Signs	Meaning
→	Guide to actions
●	Enumeration
<i>Italic</i>	Name of a button, push-button, switch

### 1.2 Safety-related information

The symbol cautions against a physical injury.

This instruction manual contains safety-related information:

- in chapter 3 Safety,
- as warnings in individual chapters,
- in the enclosed documents of the third-party manufacturers, see chapter 1.3 Non-company documents.

The safety-related information will explain to you the hazards around the machine and the method of preventing such hazards.

Please read the safety-related information carefully. Your expertise will help you to identify dangerous situations and to protect yourself and others.

#### Chapter Safety

The chapter provides information on the measures for your safety. The information ought to build awareness for safe actions.

The objective is to provide a base for trainings and briefings.

#### Warning

This instruction manual contains warnings in multiple chapters. A warning always warns you against imminent danger. It should be read in conjunction with the situation in which the warning is given.

The objective is to avoid accidents and damages.

## Instructions on reading



### SIGNAL WORD

This warning text indicates the hazard. This warning text indicates the consequences.

→ This instruction indicates the remedial actions.

SIGNAL WORD	Degree of risk of the hazard	Meaning
<b>HAZARD</b>	high	Death, grievous bodily harm will occur if the hazard is not avoided.
<b>WARNING</b>	medium	Death, grievous bodily harm may occur if the hazard is not avoided.
<b>CAUTION</b>	low	Minor or moderate injury may occur if the hazard is not avoided.

### 1.3 Non-company documents


In addition to this instruction manual, non-company documentation of the suppliers must also be taken into account. The addresses of the companies and the documents are listed in Chapter 12.1.

The non-company documents contain safety-related information. It will not be repeated in the present original instruction manual.

If the non-company documents portray hazards for the complete machine, then these are included in the risk assessment.

→  Read the non-company documents in chapter 12.1.

### 1.4 Damage to property

The  symbol cautions against property damage. The property damage is illustrated as follows.



#### Damage to property

This text indicates the property damage. This warning text indicates the consequences.

→ This instruction indicates the remedial actions.

## **2 Legal regulations**

### **2.1 Exclusion of liability**

The statutory national and European regulations shall apply.

### **2.2 Modifications**

Modifications can cause new hazards to the machine. Severe physical injuries are possible. The hazards must be re-assessed after the modification. The whole area of the machine and all operation phases will be included.

- The manufacturer must perform a risk assessment.  
If the machine is changed substantially in terms of the Machinery Directive 2006/42/EC, the EC Declaration of Conformity and the CE Marking shall no longer remain valid. The modifier can become the manufacturer.
- The manufacturer must perform a risk assessment.  
If the work equipment is changed, the health and safety requirements must be met pursuant to the Ordinance on Industrial Safety and Health. It must be clarified if there are manufacturer obligations.

In case of maintenance work, only original spare parts or spare parts that match the specification of the original spare part, must be used. Use of other parts may result in the loss of the manufacturer's liability. The liability is then transferred to the converter or the operator.

### **2.3 Existing directives**

- Refer to the EC Declaration of Conformity in chapter 12.

### **2.4 Sale in the non-European economic area**

The manufacturer shall not be liable in case the machine is modified in the non-European economic area. The machine is designed, built and documented only for the European economic area.

If the machine is resold in the non-European area, the seller shall fulfil the obligation of all the legal requirements of the respective economic area/country.



### 3 Safety

#### 3.1 Intended use

The machine has been designed and built by deconta GmbH, Im Geer 20, 46419 Isselburg.

The machine can be implemented.

The mobile decon unit deco mobil C is a multi-chamber system, enabling a step-by-step transition in the contaminated area as well as leaving the contaminated area safely, without carrying fibers out of the dirty area.

In this decon unit system, the air lock is put under negative pressure to avoid asbestos fibers leaving the working area. This might happen via an air exchange or by transfer of fibres, e.g. on work clothes.

The mobile decon unit is not meant for usage in condensing, corrosive, inflammable and explosive room air. The ambient and medium temperature must be between +5 to +50°C.

The machine may:

- be used only for commercial and industrial purposes,
- be operated outdoors,
- not be used in potentially explosive surroundings.

The machine is built according to the state of the art and the recognised safety rules.

Yet, improper or unintended use of the machine may lead to hazards to life and limb of the user or of third parties or to damages to the machine and other tangible assets.

The intended use covers the compliance with this instruction manual as well as machine instruction manuals of suppliers and the compliance with the inspection and maintenance requirements of the suppliers.

The manufacturer shall not be liable for non-compliance and for the resulting damages. The operator shall bear the risk.

If there are faults during operation:

- switch off the machine immediately,
- Inform the specialised staff or the suppliers.



#### **WARNING**

Never move the trailer with a full tank!

- Always empty the tank before driving (chap. 4.4)

**Reasonably foreseeable misuse**

Every use other than the one described in this instruction manual shall be deemed as a reasonable foreseeable misuse.

This includes:

- operation in potentially explosive surroundings,
- the mechanical or electrical bypassing of machines or machine parts.
- the use of parts other than the original parts or parts outside the specification of the replaced part.
- Modifications, alterations and manipulations.
- the use for processing other substances than intended.
- the non-compliance with instructions and specified operation, maintenance and repair requirements.
- the non-compliance with rules and regulations in the country of use and the statutory regulations and accident prevention regulations when dealing with this machine.
- the operation of the machine outside technical data. This includes the technical data of the machine and the individual machines.

## 3.2 Technical data

### Dimensions of the machine

Description	Value
ECO 3000 3 chambers, box body L x H x B	approx. 2826 mm x 2020 mm x 1524 mm
C 4000 3 or 4 chambers, box body L x H x B	approx. 3826 mm x 2020 mm x 2018 mm
C 5000 3, 4 or 5 chambers, box body L x H x B	approx. 4586 mm x 2020 mm x 2018 mm

### Connections

Description	Value
Supply voltage	230 V / 50 Hz
Control voltage	24 V
Operating pressure of pneumatics	3 bar
Operating pressure of water	4 bar

### Environmental conditions

Description	Value
Humidity	40 – 70 %
Permissible ambient temperature	5 °C to 50 °C

### Noise emission

Description	Value
Emission sound pressure level LP	< 70 dB(A)

→ Follow the technical data in the documents of the suppliers in chapter 12.1.

Safety

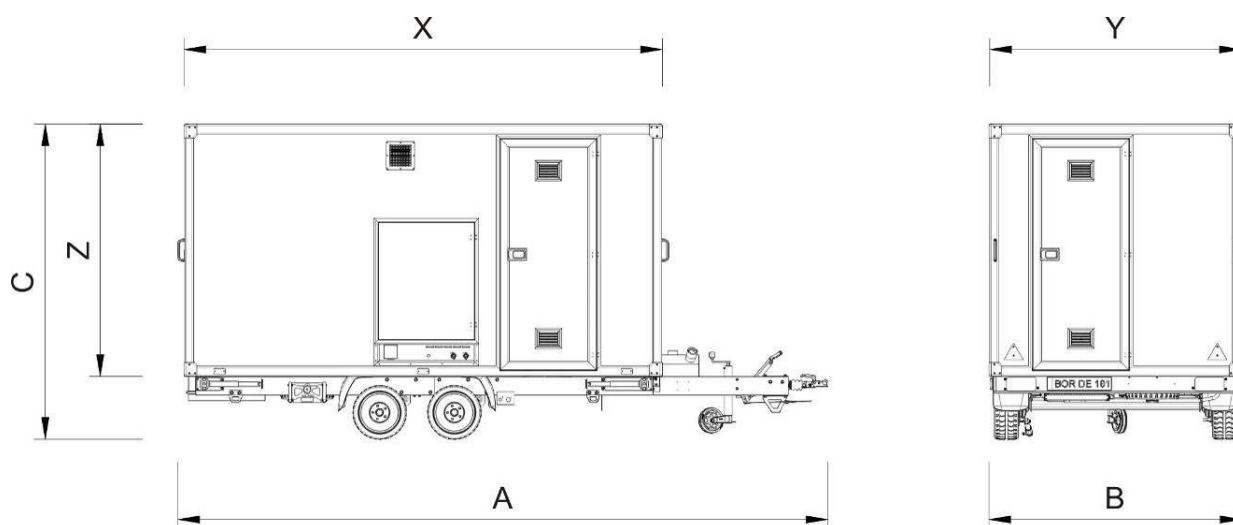


Fig. 1 1 Dimensions of deco mobil C

Overall dimensions	ECO 3000	4000	5000
Length A	4304 mm	5210 mm	5970 mm
Breadth B	1972 mm	2040 mm	
Height C	2350 mm	2520 mm	
<b>Box body</b>			
Length X	2826 mm	3826 mm	4586 mm
Breadth Y	1524 mm	2018 mm	
Height Z	2020 mm		

### 3.3 Maschine

#### 3.3.1 Emergency stop, emergency shutdown system, main switch

System	Location	Function
Main switch with emergency shutdown function E-version	Control cabinet in the technical room	Machine is disconnected from the mains
Battery main switch automatic version	Control cabinet in the technical room	Machine is disconnected from the mains

The shutdown and emergency shutdown systems:

- must be easily accessible,
- must lock when activated,
- work directly.

Shutdown and emergency shutdown systems are operated only in case of emergencies. Therefore, their dysfunction is rarely noticed. During an emergency, a dysfunction can lead to fatal or severe injuries.

→ Inspect shutdown and emergency shutdown systems regularly.

Restart after emergency shutdown

- Check the cause for actuation,
- do not operate the machine if the cause is unknown,
- Eliminate the cause,
- Reset the shutdown or emergency system,
- Start the automatic mode.

The main switch of the machine is switched off during maintenance work and secured with a lock to prevent it from being switched on again or the lever of the battery main switch is removed.




#### 3.3.2 Regular inspection of safety equipment

The protective devices have been designed such that if used as intended, the risk of injury has been reduced to a residual risk. If protective devices are not functioning, severe injuries can be caused.

- Do not manipulate and modify protective devices,
- Always operate the machine with functioning protective devices,
- Remove the protective devices only the main switch is off and this switch is secured from restart,
- mount the protective devices again and check the functioning after repair.

**3.3.3 Protective conductor, earthing and equipotential bonding**

The following is installed on the machine:


Description	Function	Pictogram
Protective conductor	<ul style="list-style-type: none"> <li>protects persons from an electric shock</li> </ul>	
Earthing	<ul style="list-style-type: none"> <li>leads the fault current into the soil.</li> </ul>	
Equipotential bonding	<ul style="list-style-type: none"> <li>Establishing electrical connections between conductive parts in order to achieve equal potential</li> </ul>	

**3.3.4 Labels on the machine**

Safety-related information is attached to the machine in the form of pictograms and/or labels. They indicate risks, which:

- occur frequently and/or
- have serious consequences.

The following labels are attached to the machine:

Meaning	Location	Label
Warning against dangerous electrical voltage	Control cabinet	

### 3.4 Safety instructions

#### 3.4.1 According to the source of the hazard

##### Power Electrical energy

The supply voltage of the machine is 230 V. Touching live parts leads to fatal electric shock.

- Before performing any work on the machine, switch off the main switch and secure against restart,
  - replace the damaged wire immediately,
  - inspect the protective conductor system regularly, □
  - Close the control cabinet after the work is complete and remove the key,
  - during disassembly, disconnect and remove the supply cable.
- 

##### Pneumatic energy

Compressed air is supplied to the machine through a plant connection. The pressure is 6 bar. Escaping compressed air may lead to severe injuries.

- Before performing any work on the machine, depressurise the system sections and pressure lines to be opened and secure against re-pressurisation,
  - do not pressurise loose pneumatic hoses with compressed air,
  - Replace the pneumatic hoses according to the manufacturer's instructions,
  - Check brackets and connection regularly.
- 

##### Cold Shower water in the shower

**Heat** Before switching on the pump of the shower water, keep the shower head away from the body.

- If the water has not been heated, there will be no cold shower,
  - If the water is too hot, there will be no burning.
- 

**Positioning** Always place the machine horizontally on a fixed, stable base. Extend all supports. An unsecured or incorrectly placed machine can lead to injuries due to rolling and overturning.

- Align horizontally,
- extend all supports,
- pull off the step and then lock the safety bolts,
- make the power connections correctly,
- activate and set the control system.

##### Substances Materials

**Air filter, sewage water filter and disinfection**

Air and water filters are used on the machine. These filters must be regularly replaced. The filling level of the air filter is indicated on menu page 1 of the control system. The sewage water filter must be changed every week or everyday in case of heavy load. A special program must be started in the control system for disinfection.

- Wear PPE,
  - Dispose of the filter as per the manufacturer's instructions.
- 

**Fire  
Burning  
Explosion****Overheating**

The control cabinet is not equipped with a fan. If air vents are cluttered up or obstructed, heat will accumulate. Cable insulations can melt. Fires can break out. Smoke poisonings and burnings are possible.

- Keep ventilation slots open and clean,
  - maintain adequate distance from the adjacent machines or building parts,
  - Place fire extinguishers around the machine.
- 

**Ageing  
Wear****Unnoticed wear**

The machine and its safety equipment are subject to ageing. The components have been designed according to the expected loads. Despite this, they age and wear out. Components can become defective earlier than expected. If ageing, wear and defective parts are not identified, it may lead to severe injuries.

- Follow the maintenance plan,
  - perform regular visual inspections.
- 

**Labelling of the operating and indicating elements**

The operating and indicating elements are labelled. This will prevent an operating error. Absence of labels may lead to physical and machine damages.

- Keep actuators, controls and labels clean,
  - replace damaged labels.
-



**Human error**

## Traffic routes

In case of work on and around the machine, auxiliaries and components are stored in the working area. There is a tripping hazard for storage in the traffic routes. This hazard also exists while saying wires and cables in the traffic routes. Persons can slip on leaked liquids.

- Do not lay down connection lines and cables in traffic routes,
  - Store objects, loose cables outside traffic routes.
  - remove tools and other working tools after repair work,
  - Always keep the machine vicinity clean and dry,
  - absorb spilled material immediately.
- 

## Software

The machine is controlled by the software and program of deconta GmbH. The software and the program are tested and geared to the machine. The use of other software and changes in the program can lead to physical and machine damages.

- Use the tested software,
  - appoint trained specialised staff.
- 

**3.4.2 After the operation phase****Transport**

## Power connections

The machine is connected to its energy sources. Cables and wires can be damaged even with a minor change in the location.

Cable damage can cause metal parts to become live. Cables can break off and be exposed. An electric shock is possible.

Fluids may leak out due to wire ruptures and leaky couplings. Skin injuries are possible. Slipping is possible.

Gases may escape unnoticed due to wire ruptures and leaky couplings. Burns, unconsciousness and difficulty in breathing are possible.

- Disconnect the machine from the energy sources prior every transport.
-

## PSA

For transport, the machine must be attached to the towing vehicle. Hands can be squeezed or grazed during these processes. Serious injuries to the feet and toes are possible.

- Wear a safety helmet,
  - Wear protective gloves,
  - Wear protective footwear.
- 

## Use transportation vehicles

Too small sized transportation vehicles can be overloaded due to the load.

The functionality and roadworthiness can be affected. The interferences must not be immediately visible and may occur only during transportation.

- Dimension the transport adequately according to the weight and measurements.
- 

**Assembly  
Disassembly**

## Store tools and components

Tools can be stored outside tool storages. Components are available for installation. Persons can trip over and fall.

- Plan adequate mounting surfaces and storage areas,
  - Do not store tools and components in the traffic routes or on confusing places,
  - Clean up tools after the work is complete,
  - if required, block the traffic routes for third parties.
- 

## Establish connections

Establish electrical connections to the power supply.

- Pay attention to correct connections,
  - Check the protective conductor function.
-

## Safety

---

### Operation Control

#### Set-up

The system is PLC-controlled. The PLC stores the times, temperatures and fill levels, among other things. The corresponding information must be entered during the setup mode.

- Only specialised staff is allowed to work in the setup mode.
- 

### Maintenance

#### Change components

- The parameters and design of the machine components are synchronised. The exchange for unsuitable components can cause malfunctions and hazards for the persons working on the machine,
  - use original spare parts only or spare parts that meet the specification of the original spare part,
  - Follow the bill of materials.
- 

#### Rectify the fault

Parameters are saved in the control system. These parameters are synchronised. They can influence one another. The functioning of the machine can be disturbed by minor alterations. Only the specialised staff is aware of the connections and dangers that may occur during fault correction.

- Faults may be corrected by specialised staff only.
- 

### Disposal

#### Avoid environmental damages

The machine contains filters that endanger the environment if not used properly.

To avoid environmental damages, proceed as follows. Materials and components:

- sort,



- Do not throw parts in the dustbin,
- Follow the safety data sheets of the used filters,
- dispose as per the statutory regulations,
- get it picked up and recycled by a specialised company.

### 3.5 Operator

#### 3.5.1 Operation of the machine

The operator:

- operates the machine in all operation phases and without manipulations,
- ensures that the staff reads and understands the instruction manual,
- instructs the staff before the initial commencement of work,
- keeps the instruction manual handy near the machine in paper form.
- obtains the instruction manual and non-company documents in a legible condition.

#### 3.5.2 Action during accidents

The operator instructs the users regarding the action to be taken during accidents. The content of the instruction includes for e.g.:

- the locations for first-aid stations,
  - the location and the course of the escape routes,
  - the conduct in case of emergencies and the regular exercise of the conduct.
- After the first-aid measures, look for a professional medical treatment immediately.

### 3.6 Staff

#### 3.6.1 Description of the user groups

##### Specialised staff

Specialised staff are specialists, whose:

- professional training,
- work experience,
- appropriate professional activity practiced in a timely manner,
- personal qualities

enable them to perform skilled work on the machine. They are appointed and trained by the operator.

Specialised staff:

- is qualified with a successfully completed and recognised education in its area of expertise
- has knowledge and experience in dealing with machines/systems,
- can assess and independently perform the work task,
- has the knowledge of the application of the applicable standards or the ability of getting this knowledge,
- has the knowledge of the hazards occurring in its area of expertise as well as the knowledge regarding their prevention and elimination.

The following specialised staff is required for operating the machine:

- for work on the electrical equipment,
- for controlling and programming,
- for the set-up and testing work,
- for maintenance and repair,
- for fault rectification,
- for transportation, assembly and disassembly work.

The specialised staff will be instructed by deconta GmbH prior commissioning.

### **Operator**

Operators are persons who work on the machine in the automatic mode. Operators:

- can read,
- understand the symbols and instructions attached to the machine,
- can perform the activities independently and according to the specifications after instruction and apprenticeship,
- identify the hazards and can respond accordingly to the specifications after instruction.

### **Support staff**

Support staff are persons, who perform such work around the machine, which is not included in the operation. This includes e.g. cleaning. The support staff must not operate the machine. The support staff:

- can understand instructions,
- can implement instructions during its activity,
- identify the hazards and can respond accordingly to the specifications after instruction.

**Trainees**

Trainees are persons who are undergoing a professional training. They are allowed to operate the machine under the supervision of the specialised staff or to take over work tasks from its area of expertise. Trainees:

- can understand instructions,
- can implement instructions during their activity,
- identify the hazards and can respond accordingly to the specifications after instruction.

**3.6.2 Restricted access****User groups**

The user groups may obtain access only as per their qualification. The operator:

- assigns the persons to a user group,
- defines the access authorisations to the machine, to the control panel, control system and to the program,
- instructs the user groups.

**Age**

The users of the machine must be 18 years old. Trainees below the age of 18 may operate the machine only in the presence of a trainer for the purpose of training.

**Health**






The machine may not be operated by persons who are influenced by reaction-minimising medicines or are simply not in the position to operate due to health reasons.

The users must be in a position to identify the visual and acoustic hazard signals.

- Expel unauthorised persons from the machine.

**3.6.3 Personal protective equipment - PPE**

Personal protective equipment of the users includes:

PSA	Please wear the PPE during:	Pictogram
Safety helmet	<ul style="list-style-type: none"> <li>• Assembly and disassembly</li> </ul>	
Respirator mask	<ul style="list-style-type: none"> <li>• Switching of the air filter</li> </ul>	
Safety gloves	<ul style="list-style-type: none"> <li>• Maintenance and repair,</li> <li>• Assembly and disassembly</li> <li>• Filter change</li> </ul>	
Protective footwear	<ul style="list-style-type: none"> <li>• all activities</li> </ul>	
Protective clothing	<ul style="list-style-type: none"> <li>• all activities</li> </ul>	

## 4 Machine description

The decontamination units are available in three sizes with a different number of internal chambers. The type of decon unit to be used depends on the type of contamination and the legal requirement of the respective country, in which the lock is used.

The operator of the decon unit defines the corresponding requirements.

Basically, the decon units are designed in such a way that the employee enters the contaminated room of the decon unit from the contaminated environment.

The contaminated room is usually located at the tail of the trailer. In this room, the overalls can be put in a collecting tank or can be vacuumed with a hand vacu-um cleaner (option). In any case, there is a negative pressure device in this room, which extracts the air through a filter. The negative pressure gradient leads to the clean room through the other rooms till the contaminated room. Thus, it is not possible to carry over the dust from the contaminated area.

After the contaminated room comes the shower. Here, warm water is available for showering.

Then comes the clean room, where the employee can wear his or her streetwear again.

Depending on the version, up to two further rooms can exist. Here, a separate flap can be installed for disposing of the work clothes as well as another shower or even a hand washbasin.

Optionally, there are two compressed air connections in each room, in order to supply air to the respiratory masks of the employees.

The control system of the decon unit is located in the clean room. The space heater is switched on here. Refer to chap. 4.4 for a description of the control system.

The decon units described here are available for two energy supplies - electrical and autarkic.

The electrical version is supplied permanently with 230 V. All the required loads will be fed from the mains.

The autarkic version has batteries in the technical room and the unit receives the required power from these batteries. Recharging the batteries happens via the 230 V power supply when connected. There is also an option of a solar system.

In addition, a diesel tank can be mounted on the tow hitch A frame . This option heats up the shower water using a Webasto heater.

Water is supplied to the shower by the internal water tank, water is supplied to the unit either directly fed by connecting to the mains water supply or via an optional pump from an external water container. In the case of the optional water pump this conveys the water from the external water container to the internal water tank.



## Machine description

### 4.1 Scope of delivery

The decon unit is always shipped as a trailer permitted for road transport.

The possible equipment and options are described in our own documentation in chapter 12.

### 4.2 Structure

#### 4.2.1 Structure of the deco mobil C ECO 3000

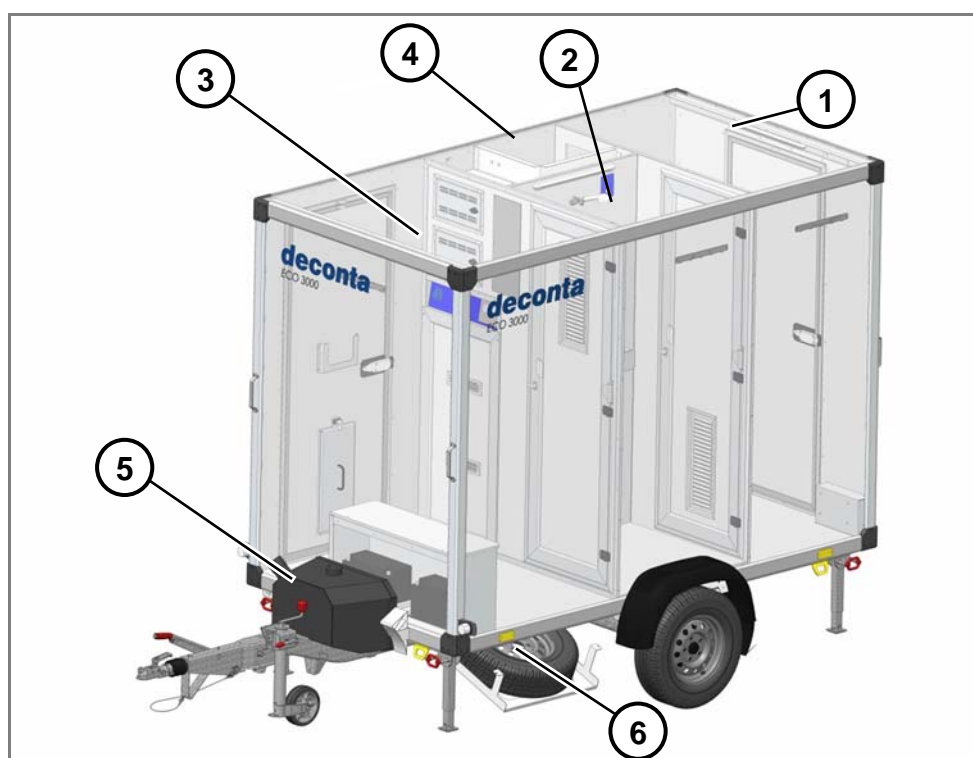


Fig. 1 2 View of ECO 3000

Pos.	Description
1	Contaminated room
2	Shower
3	Clean room
4	Technical room
5	Diesel tank
6	Spare wheel

Here, the optional diesel tank on the drawbar and the spare wheel must also be identified.

## Machine description

### 4.2.2 Structure of deco mobil C 4000

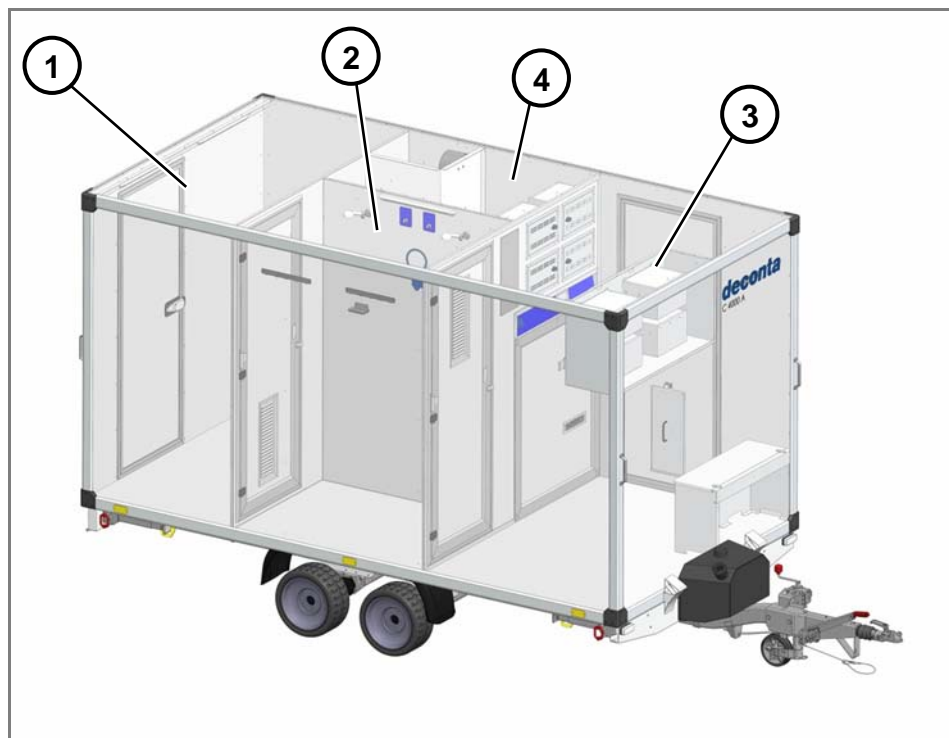


Fig. 1 3 Structure of deco mobil C 4000

Pos.	Description
1	Contaminated room
2	Shower
3	Clean room
4	Technical room

## Machine description

### 4.2.3 Structure of deco mobil C 5000

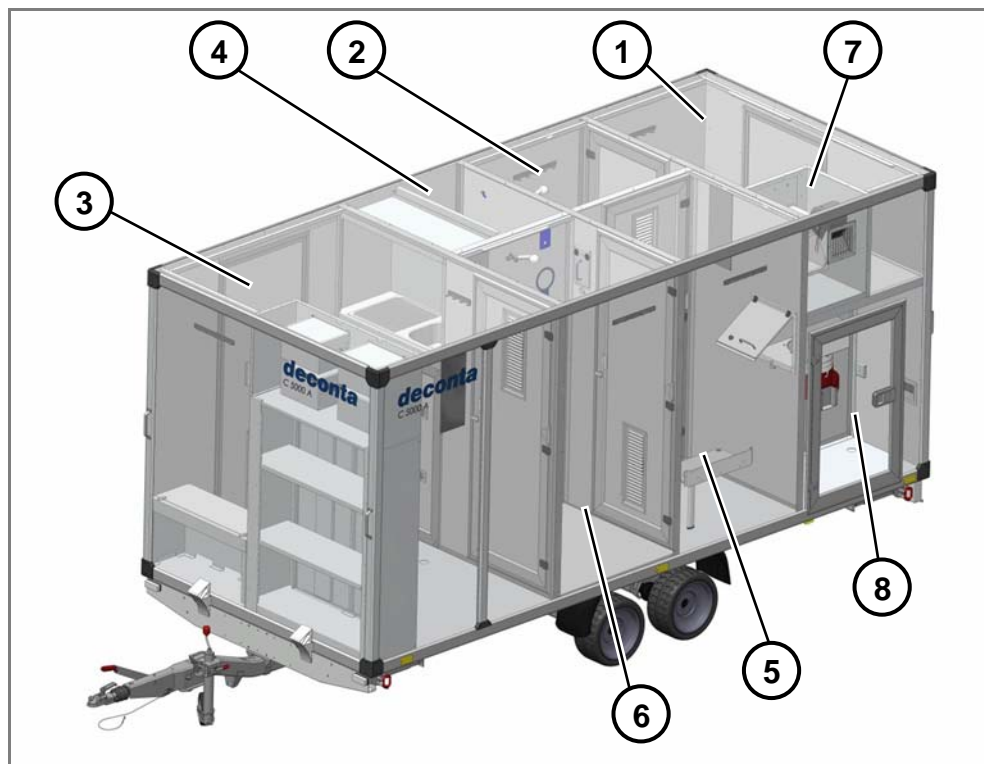


Fig. 1 4 Structure of deco mobil C 5000

Pos.	Description
1	Contaminated room
2	Shower 1
3	Clean room
4	Technical room
5	Intermediate room
6	Shower 2
7	Negative pressure and filtering plant
8	Chamber for vacuum cleaner and waste system

## Machine description

### 4.2.4 Options of deco mobil C

The following section illustrates exemplary drawings of three types with possible options.

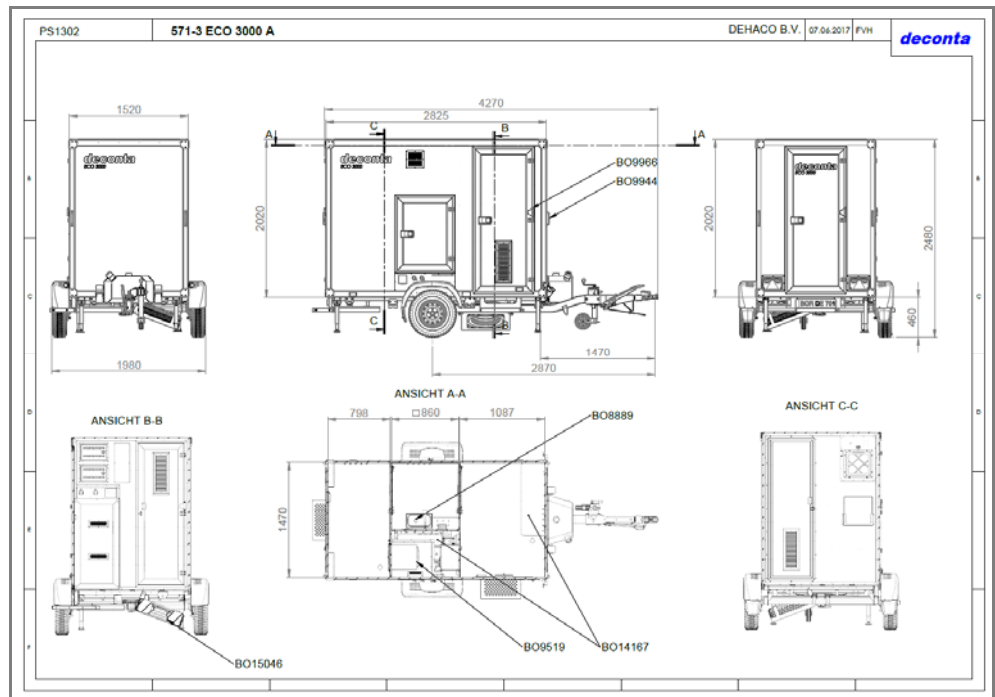


Fig. 1 5 Options of deco mobil C ECO 3000

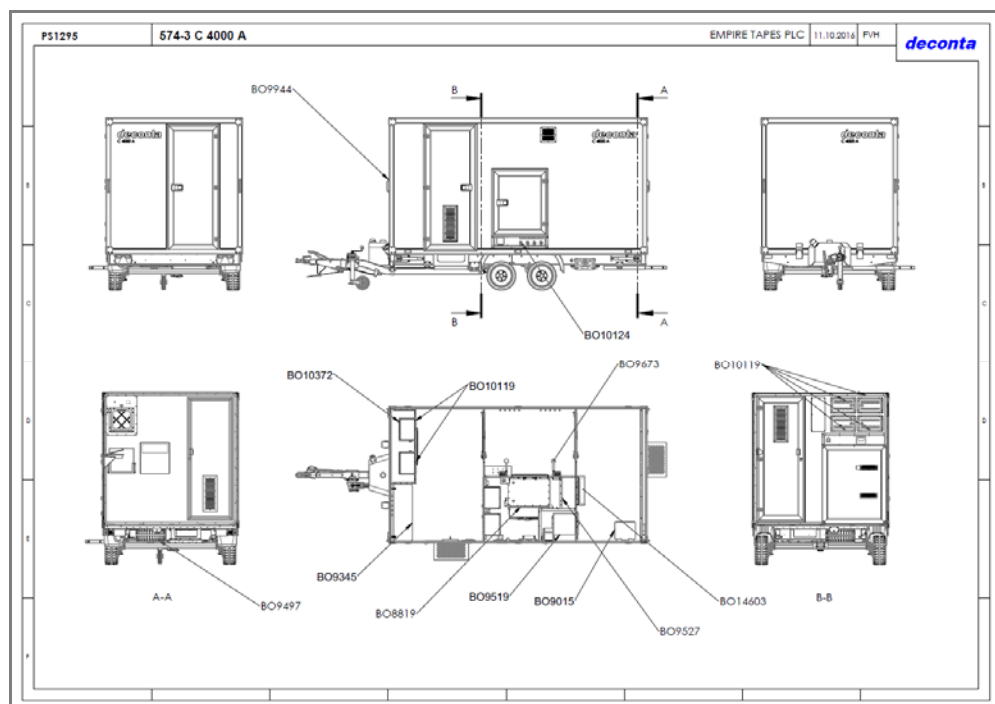


Fig. 1 6 Options of deco mobil C 4000

## Machine description

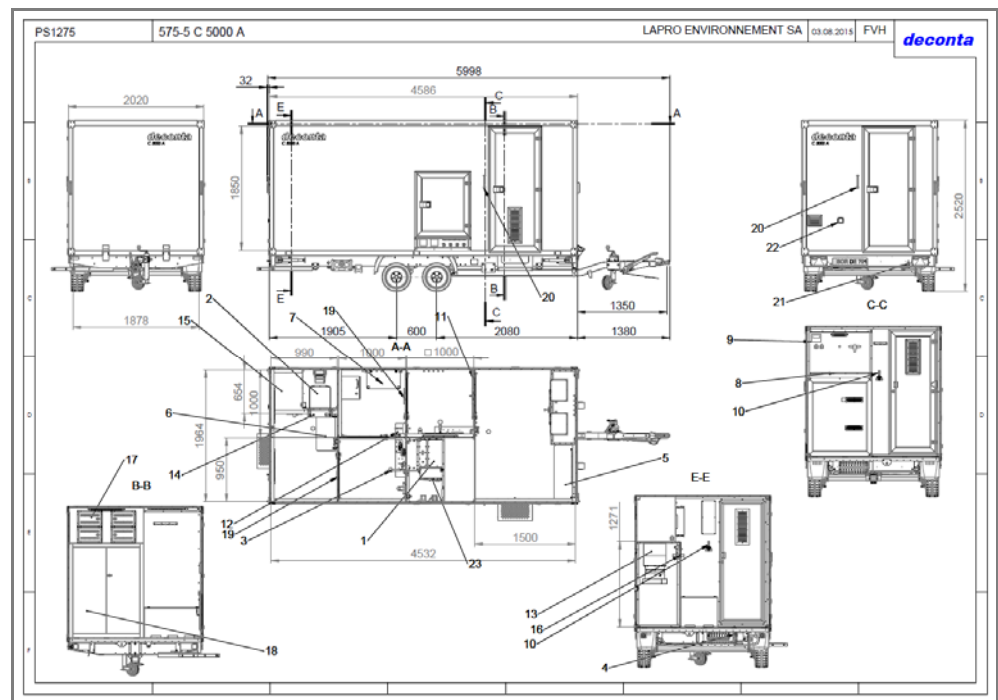


Fig. 1 7 Options of deco mobil C 5000

### 4.3 Supply of energy and operating materials

The power supply differs in two types:

#### Autarkic version

Diesel water heating and room heating via a 4 kW WEBASTO - diesel warm water generator. An integrated onboard battery allows the use of all loads without external power connection (autarkic operation, when connected to 230 Volt, battery is automatically charged).

#### Electric version

Electric water heating via 3 kW heating rod, power supply of 230 Volt is necessary for the operation.

Machine description

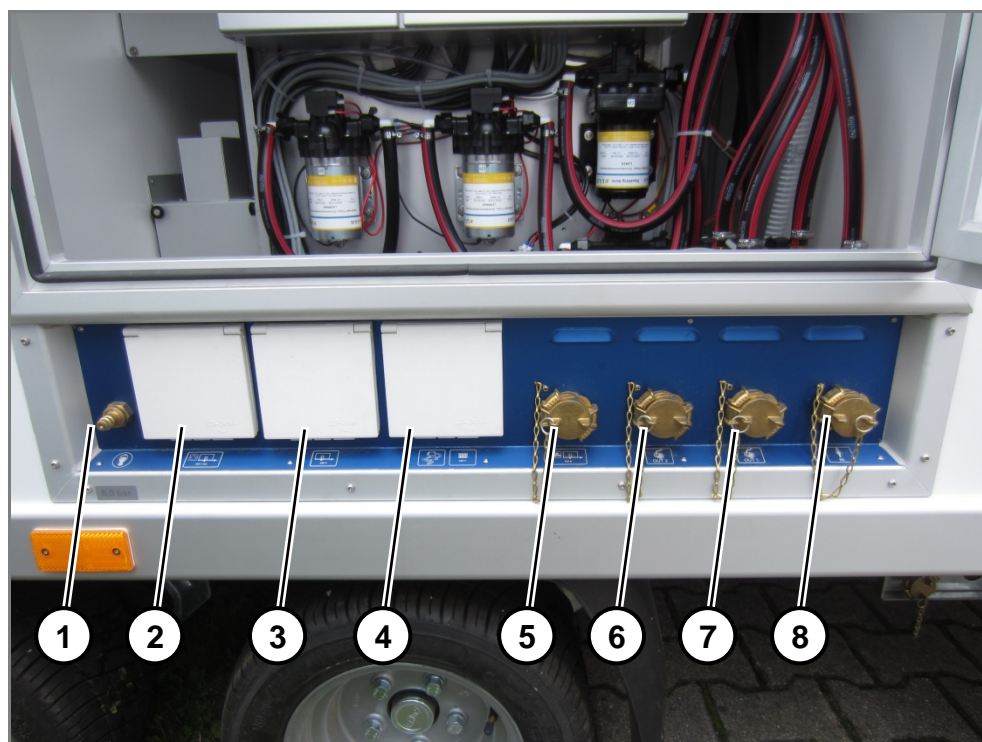


Fig. 1 8 Position of the supply connections

Pos.	Description
1	Compressed air supply (option)
2	Passthrough to the contaminated area (option)
3	Supply to deco mobil C
4	Supply for el. room heating and vacuum cleaner (option)
5	Water passthrough to the contaminated area (option)
6	Filtered sewage water from shower 2 (option)
7	Filtered sewage water from shower 1
8	Drinking water connection

## Machine description

---

### 4.3.1 Electrical

Electrical power is supplied to the machine through the control cabinet. The supply voltage is 230 V. The supply is via sockets below the supply chamber (Fig. 8).

Pos. 2 is an option and provides a pure passthrough of electrical supply to the contaminated area. The appropriate socket is located next to the entrance door in the contaminated area (red circle Fig. 9).

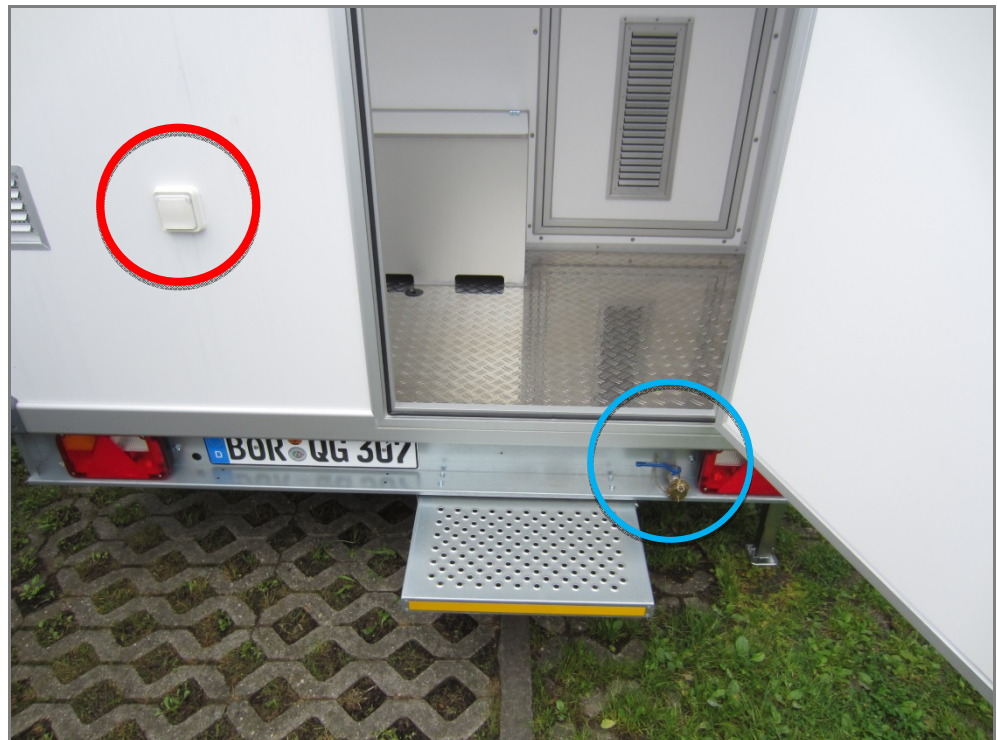


Fig. 1.9 Position of the socket and water supply in the contaminated area

### 4.3.2 Pneumatics

The compressed air for the machine will be generated in an external pneumatic system. The machine is connected to the pneumatic system through the supply inlet (Pos. 1, Fig. 8). The operating pressure is 3 bar and the maximum pressure is 6 bar.

## Machine description

---

### 4.3.3 Water

The water comes from the public water supply or from containers.

**Use only water of drinking water quality and a max. Degree of hardness of 14 °dH (soft to medium).**

**If the water contains lime or if you find that the water heating takes longer than usual, we recommend decalcifying the water tank about once per quarter.**

The maximum inlet pressure is 4 bar.

The connection (Pos. 8, Fig. 8) is used for the public water supply.

For the water supply from containers, the option Depressurised connection can be used (Fig. 10).

The cock for the water supply in the contaminated area is located next to the entry level (blue circle, Fig. 9)



Fig. 1 10 Depressurised connection

### 4.3.4 Fuel

Bei der autarken Variante kann auf der Deichsel ein Dieseltank mit 25 l Inhalt installiert werden. Es wird normaler Dieselmotorkraftstoff verwendet.



## Machine description

---

### 4.4 Operating and indicating elements

#### 4.4.1 Shower and vacuum cleaner push-buttons

Only one push-button is required for operation in order to operate the shower and if required, the vacuum cleaner (Fig. 11, Fig. 12).

If pressed once, the function is activated and if pressed longer, the function is deactivated.

The description of the general control system of the mobile decon unit is given in chap. 8.2.1.



Fig. 1 11 Push-button for activating the shower (red circle)

**Machine description**

---



Fig. 1 12 Push-button for activating the vacuum cleaner (red circle)

## Machine description

### 4.4.2 Ballcock

In the shower chambers, the ballcock (option) marked as 1 - 6 can be selected, in which the water chamber is sucked and pumped out by the sewage water filtering plant. Here, it is extremely important to ensure that only one ballcock is opened in each shower chamber.

When the sewage pump function is activated, the sewage pump automatically starts with the switch "shower water start" and pumps the contaminated shower water via a 2-stage filtering plant. The filtered sewage water is discharged at the "filtered sewage water" connection (Pos. 6 and 7, Fig. 8).

If the sewage filtering plant is not activated, no sewage filtration takes place during a showering process. The accumulated shower waste water will then escape at the "unfiltered sewage water" connection (Pos. 2, Fig. 15).

The ballcock for the fresh water discharge is located in the technical room of the mobile decon unit (Fig. 14).

If this ballcock is opened, the water discharges at the "empty tank" connection (Pos. 1, Fig. 15).

It is absolutely necessary to empty the tank before moving the trailer.



Fig. 1 13 Ball cock in the shower chamber

Machine description

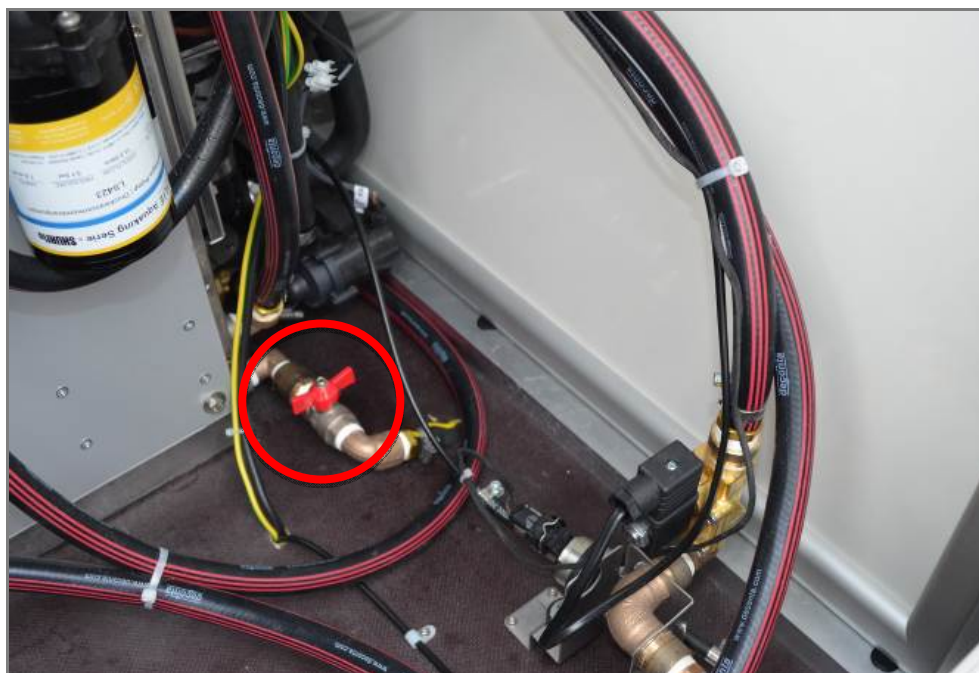


Fig. 1 14 Ball cock for emptying the tank in the technical room

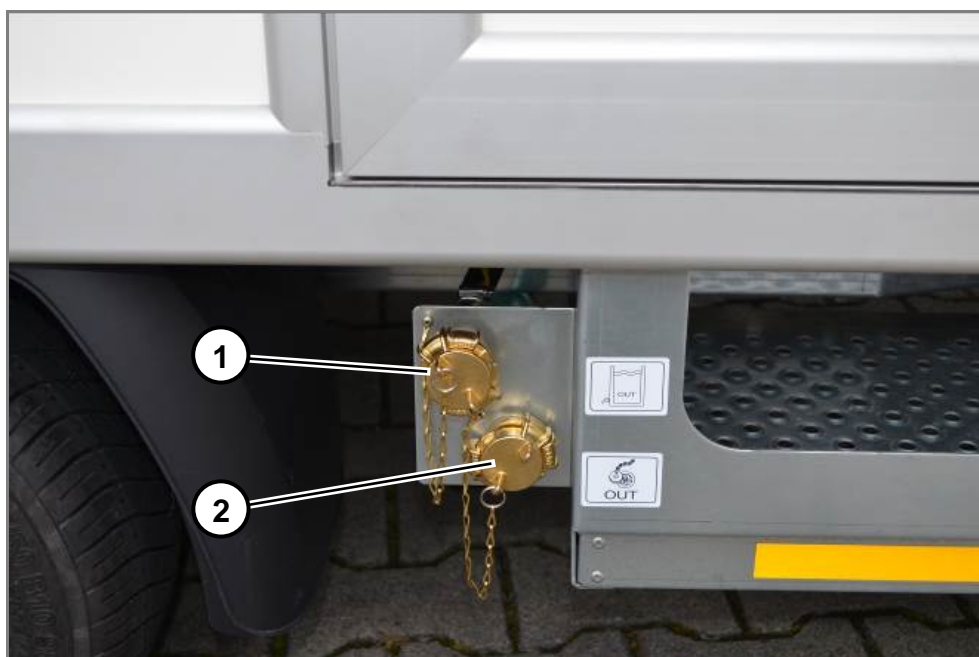


Fig. 1 15 Discharge of fresh water tank

Pos.	Description
1	Discharge of fresh water tank
2	Discharge of unfiltered sewage water

## Machine description

---

### 4.4.3 Emergency shutdown switch

The emergency shutdown switch is located on the control cabinet in the technical room (Fig. 16).

In the autarkic version, the battery main switch is located at this point (Fig. 17).

When the Mains power supply is correctly connected, the green indicator lamps above the switch will be illuminated.



Fig. 1 16 Emergency shutdown switch



Fig. 1 17 Battery main switch

#### **4.5 Workstations**

The mobile decon unit does not have any workstations, because it only decontaminates employees.

#### **4.6 Function**

The contaminated employee enters the mobile decon unit in the contaminated area. The contaminated area is under continuous negative pressure,

the air that is extracted from this area is filtered by the onboard NPU with fitted HEPA filter. In this way, no contaminated dust can get into the outside air. There is a compressed air supply in this area and in every other room in order to supply compressed air to the respiratory mask and to the employees.

There is an option of connecting a vacuum cleaner in the contaminated area, this facilitates the vacuuming of workwear prior to getting undressed. The work clothes are hereby sucked off.

After the contaminated area chamber, the employee reaches the shower. The shower pump is started via a switch or a push-button. The water flow is adjusted by a pump or optionally by a water fitting.

After the shower, there can be an additional room in which the work clothes are collected in an optional waste system.

The waste system and the vacuum cleaner are discharged from the outside.

After showering, the employee exits the area and goes to the clean chamber.

Optionally, other chambers can also exist depending on the type of mobile decon unit.

In the clean chamber, the employee dons his or her normal street wear and can exit the mobile decon unit.

The clean area also contains the control system for different functions of the mobile decon unit.

**5 Transport****5.1 Operation on road****5.1.1 General description of the trailer****Vehicle category:**

Vehicle of category O2, 750 kg to 3500 kg allowed gross vehicle weight.

**Coupling system:**

Ball head coupling Ø 50 mm pursuant to 9420/EC.

**Electrical connection of towing vehicle:**

Plug connection 13-pin, pursuant to ISO 11446.

**Box layout:**

Floor, exterior and interior wall material in sandwich- construction. Frame construction in aluminum.

**Operating limits**

Size, style and features determine the tare weight and the mass of a trailer at distribution ex-factory. Loading and unloading by the owner changes the support load and the weight. The following operating limits may not be exceeded or undercut:

Maximum permitted speed: 80 km

Gross vehicle weight: see identification plate

Permissible maximum mass: min. 40 kg max. 100 kg

Permissible floor loading: 100 kg/m<sup>2</sup>, evenly distributed (only within permissible limits)

Permissible roof load: none

No driving in storms and heavy winds.

Please observe the national laws for the operation of the trailer on the road prior to the details in this instruction manual.

**5.1.2 Checks prior to any journey**

- Trailer completeness check, any loose components and everything intact?
- Supports retracted completely?
- Entry aids fully retracted?
- Ball head visibly and audibly locked (see section 1.6)?
- Contact-braking cable positioned?
- Drawbar stabiliser hoisted and secured?
- Electrical connection established?
- Hand-brake released?
- Wheel chocks removed?
- Lighting checked?
- Tyres and air pressure checked?
- All doors closed and secured?
- Roof free of snow and ice?
  
- Before each journey, test the brakes, if:
  - the overrun brake works,
  - the brakes react uniformly and
  - the trailer keeps in line during braking.

Be prepared for an altered drivability with a trailer: larger vehicle width, lower acceleration capacity and a longer braking distance!

Defects in the braking need to be remedied by an authorised specialist workshop immediately.



### 5.1.3 Regular inspections and maintenance

#### 5.1.3.1 Axle

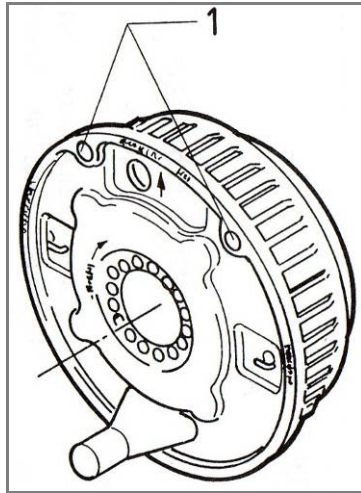


Fig. 1 18 Wheel hub and brake

After 1,500 km or 6 months

→ Check the axial clearance of the wheel hub bearing and adjust if necessary.

Every 10,000 km or 12 months

→ Check the wear of the wheel brakes on the spyhole (see Fig. 18) and adjust if required. The trailer brake is subject to higher wear and tear in case of constant ascent. For utility trailers, an earlier adjustment may be necessary.

→ Check the grease quantity and the grease condition of the tapered roller bearings and replace if necessary.



#### WARNING

Perform regular inspections.

→ All necessary maintenance work should be carried out only by trained personnel in specialist workshops or service stations.

Please also note the relevant instruction manual of AL-KO automotive engineering.

**5.1.3.2 Overrun device**

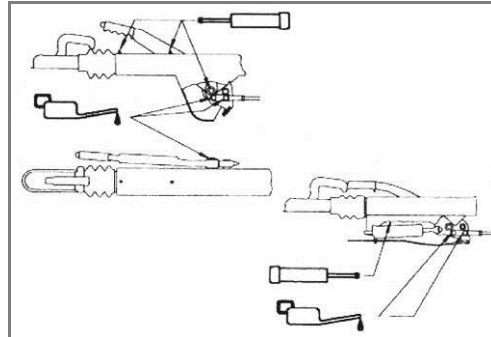


Fig. 1 19 Overrun device

Every 10,000 km or 12 months

→ every 10,000 – 15,000 km or 12 months Grease or rather oil the slide and hinge points of the overrun device. See Fig. 19 for lubricating points.

Please also note the relevant instruction manual of AL-KO automotive engineering.

**5.1.3.3 Coupling head**

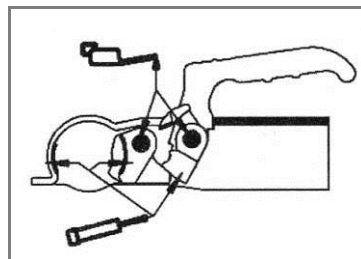


Fig. 1 20 Coupling head

Weekly or in case of obvious soil

→ Check the coupling head and clean if necessary. Grease or rather oil the spherical shell, joints and depositories. Grease or rather oil the slide and hinge points of the overrun device. See Fig. 19 for lubricating points.

Please also note the relevant instruction manual of AL-KO automotive engineering.

#### 5.1.3.4 Wheels, tyres and tyre change

- Regularly inspect tyres for uniform tread wear, profile depth and external damage. Observe the minimum tyre tread depth required by the legislator,
- Use only the tyre approved for the type of rim (see vehicle registration document),
- Always use tyres of the same construction, same make and design (summer or winter tyres).

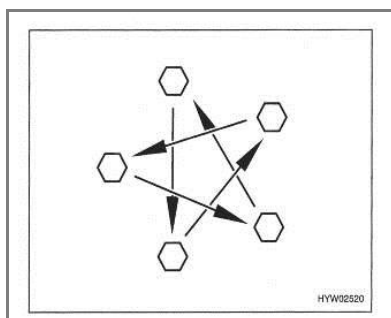


Fig. 1 21 Sequence of tightening the wheel nuts

- Tighten the wheel nuts crosswise (Fig. 21).
- Tightening torque 90 – 110 Nm.
- At the first drive, check again after approx. 100 km.
  
- Regularly check the tyre pressure of the cold trailer tyre before driving.

Tyres	Air pressure in bar
195 / 50 B 10	6,0

The air pressure value is valid for the cold tyre. The trailer is constantly adapted to the latest technical standards. It is possible that new tyre sizes are not included in this table. In this case the company deconta gladly provides the latest values.

**5.1.3.5 Tyre change**

- The trailer must be on an even, firm and stable ground.
- Use the provided jack to change the wheel.
- Before lifting the trailer, the parking brake must be applied.
- Secure the vehicle with wheel chocks on the opposite side to prevent rolling away.
- Never raise the vehicle with the crank supports attached.
- Install the jack only at the designated and marked sections (Fig. 22).
- Do not place under the raised trailer.
- The use of rims and / or tyres which are not approved for the trailer, can impair traffic safety.



Fig. 1 22 Contact points for the jack

### 5.1.3.6 Transport / towing capacity, support and axle load

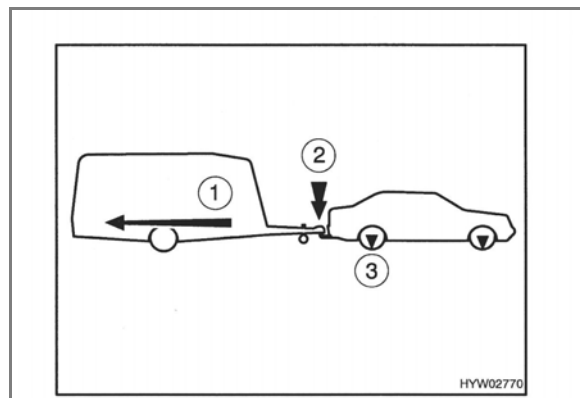
Details are important for the choice of vehicle and trailer, which are listed in the vehicle documents and defined in the operating limits.

The specified towing capacity of the towing vehicle indicates the maximum weight the towing vehicle can tow.

The support load indicates the force with which the drawbar of the trailer can press onto the trailer hitch of the towing vehicle. The maximum permissible support load must not be exceeded and the minimum support load must not be fallen short of.

The trailer may be transported only with vehicles which can certify the support load indicated on the operating limits on the trailer hitch.

The axle load has the permissible maximum load for the front and rear axles of the towing vehicle and must not be exceeded by a trailer.



- 1 Towing capacity
- 2 Support load
- 3 Axle load

Fig. 1 23 Load specifications

### 5.1.3.7 Coupling

- Place towing vehicle and trailer in position,
- Do not dock the trailer when the brake is in overrun position,
- Position the hitch of the trailer with the help of the jockey wheel over the trailer ball of the towing vehicle,
- Open the hitch (hitch handle pulled upwards) by turning the jockey wheel on to the towing ball of the towing vehicle,
- Hitch handle now snaps into place independently and audibly (if necessary, use hand to press downwards); it closes and locks automatically
- Hang the contact-braking cable with a loop around the ball head of the tow bar of the towing vehicle,
- Turn the jockey wheel all the way up and lock it parallel to the travel direction,
- Insert the light connector of the trailer into the socket of the towing vehicle; make sure that the connecting cable cannot drag on the road surface,
- Check lighting,
- Remove any wheel chocks,
- Release parking brake.



#### WARNING

Checking the snap-in indicator.

- It is properly coupled up only when the green area of the snap-in indicator is visible. Make sure that the inside of the hitch coupling is not dirty and that the moving parts of the hitch are operating smoothly.

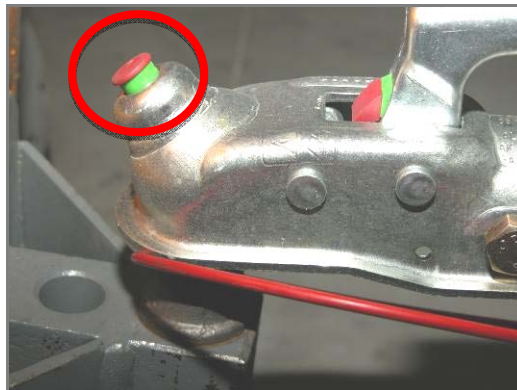


Fig. 1 24 Snap-in indicator

**5.1.3.8 Uncoupling**

- Tighten the parking brake of the trailer,
- Place the wheel chocks on both wheels,
- Remove cable of the tear-off break of the towing vehicle,
- Loosen the lighting plug and insert it into the holder on the tow hitch,
- Turn the jockey wheel down until it is firmly on the ground,
- Firmly pull up and release hitch handle,
- Use the jockey wheel to raise the drawbar so far that the towing vehicle can be driven away without danger.

After uncoupling the towing vehicle, make sure that:

- the trailer is parked on a flat and even surface.
- the trailer is not able to roll away even if it is on a slight inclined or slope
  1. Secured by the parking brake attached to the tow hitch, and
  2. Wheels are secured by the enclosed wheel chocks.
  
- The corner steady legs are lowered to the ground so that the trailer becomes stable.

**5.1.3.9 Reversing**

With reversing mechanism, it is possible to reset the trailer without any problems. In addition to the rolling resistance, a residual braking force must be overcome.

## 5.1.3.10 Wiring diagram of the plug

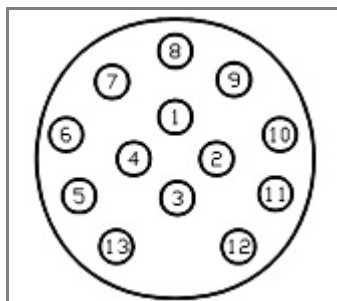


Fig. 1 25 Plug of trailer

Contact	Function	Cable colour	Wire cross-section
1	Direction indicator, left	yellow	1,5 mm <sup>2</sup>
2	Rear fog-lamp	blue	1,5 mm <sup>2</sup>
3	Measurements (contacts 1-8)	clean	1,5 mm <sup>2</sup>
4	Direction indicator, right	green	1,5 mm <sup>2</sup>
5	Right tail lamp, contour lamp, marker light	brown	1,5 mm <sup>2</sup>
6	Brake lights	red	1,5 mm <sup>2</sup>
7	Left tail lamp, contour lamp, marker light, number plate lamp	contaminated	1,5 mm <sup>2</sup>
8	Reversing light	grey	1,5 mm <sup>2</sup>



## 6 Assembly

The machine is delivered in a completely assembled condition. Additional assembly work is not required.

- Follow the information about the location,
- Follow the technical data.

### 6.1 Requirements for assembly

#### Location and stability

Conditions at the location:

- Surfaces are designed according to the loads,
- even.

### 6.2 Alignment and mounting

#### 6.2.1 Crank supports deco mobil C 4000 / 5000



Fig. 1 26 Locking device



Fig. 1 27 Positioning the crank handle

Pull out the red locking device, the support folds down. Make sure that the locking device snaps in the vertical position of the support. Extend the support with the crank handle (located on the inside of the door to the technical room).

### 6.2.2 Crank supports deco mobil C ECO 3000



Fig. 1 28 Extended support

Extend the support with the crank handle (located on the inside of the door to the technical room).

### 6.2.3 Entry aids



Fig. 1 29 Release of the step

Loosen the lateral locking device and pull out the footstep. Make sure that this snaps back to the final position.

## 6.3 Check

Please check the:

- Completeness of assembly, e.g. safety equipment, fastenings, operating elements,
- Layout and screw connections, e.g. of fasteners,
- Assembly and fit of all connections,
- Cleanliness and orderliness of the machine and around the machine, e.g. tools and packages are tidied up, machine is cleaned.

## **7 Commissioning**

The machine and the safety equipment are ready for operation and functional after actuation. Additional work is not required.

### **7.1 Prior commissioning**

The following work is required.

- Connect the power supplies (voltage, water),
- if required, fill diesel.

### **7.2 Power on**

- Observe the chapter Power on/off,
- Observe non-company documentation.

### **7.3 Inspections**

#### **7.3.1 Inspection of safety equipment**

Inspection of:

- Arrangement of jackets, housing and safety equipment,
- Functionality of the protective conductor equipment,
- Functionality of the emergency shutdown equipment.

#### **7.3.2 Checking the function**

The functional test includes the review of the functioning of the machine and the electrical characteristics. The machine is operated under normal operating conditions.

- Observe the non-company documentation in chapter 12.1.

Inspection of:

- Negative pressure and air filtering plant,
- Water heating,
- Sewage pump,
- Lighting.

#### **7.4 Commissioning**

Commissioning is denoted as the time at which the machine reaches its intended use.

- Observe the chapter Intended use,
- Observe the chapter Technical data,
- Observe the information given in the non-company documentation.

## 8 Operation and control

### 8.1 Operating modes

The machine can be operated in the following operating modes:

- Automatic mode.

#### 8.1.1 Automatic mode

After starting the smart touch control in the clean area, all functions are carried out by this control system. All the pre-set functions of the control system (light, heating, burner, water temperature...) are now active.

### 8.2 Controller

The operator controls the machine from the operating display. The controller has been made by the company deconta GmbH.

#### 8.2.1 Functions of the programmable logic smart touch control A-version (autarkic)

After switching off the main switch (in the technical room), the following screen is displayed on the operating display in the clean area:



Fig. 1 30 Main screen

Pos.	Description
1	Alarm system display activated
2	Time and date
3	Frost protection display activated
4	On/Off button

## Operation and control

Pressing the on / off button starts the control with the last set values.

- When the STEP BY STEP function is activated (see chapter 8.2.1.2), the hot water tank fills up to the minimum mark, if the function is deactivated up to the maximum mark.
- If the cold-water function (option, see chapter 8.2.1.2) is activated, the cold-water tank is filled completely; if the function is deactivated, the tank remains empty.

### 8.2.1.1 Menu page 1

After switching on, the measured values of the sensors are shown on the display. This is also menu page 1, indicated by the blue dot in the page indicator. The menu page can be switched with the button "next page" and "previous page".

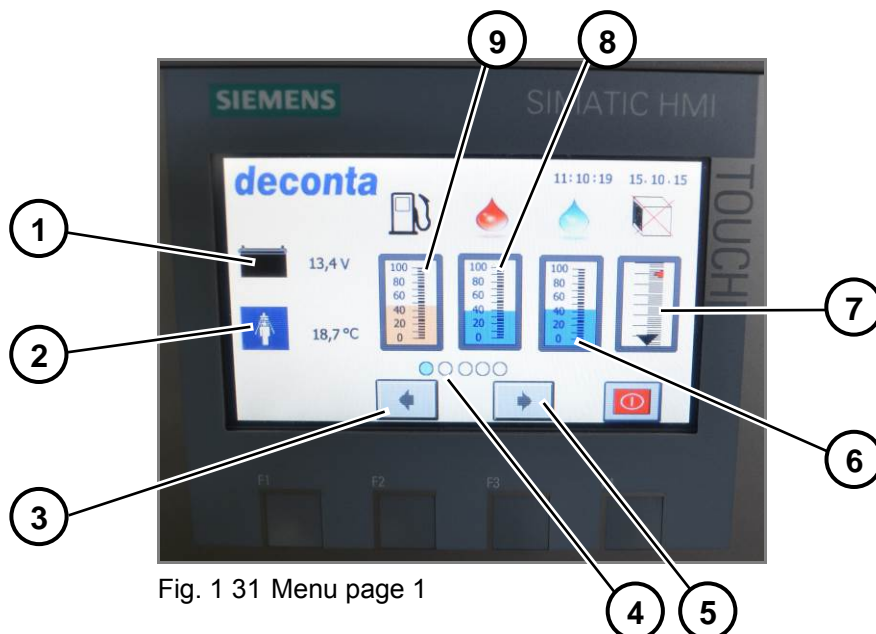


Fig. 1 31 Menu page 1

Pos.	Description
1	Battery charge
2	Temperature of shower water
3	Previous page
4	Page indicator
5	Next page
6	Filling level of cold-water tank in % (option)
7	Filter occupancy negative pressure unit
8	Filling level of hot-water tank in %
9	Filling level of diesel in %

## Operation and control

### 8.2.1.2 Menu page 2

In this menu, the individual device functions are switched on / off. The control remembers these settings so that they are reactivated immediately each time the control is switched on again.

Activated functions are shown with a green frame and deactivated functions are shown with a red frame.

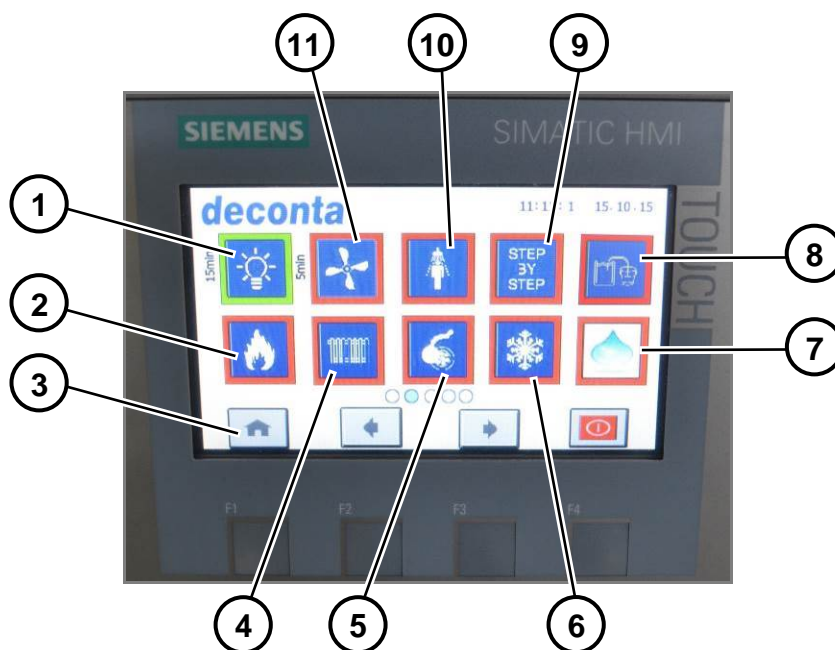


Fig. 1 32 Menu page 2

Pos.	Description
1	Light
2	Burner
3	Home
4	Room heating
5	Sewage pump
6	Frost protection
7	Cold water function (option)
8	depressurised tank filling via container (option)
9	STEP BY STEP water heating
10	Shower
11	Negative pressure (option)

## Description of the individual menu functions

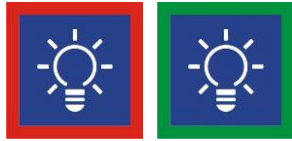


Fig. 1 33 Activation / deactivation of LED light

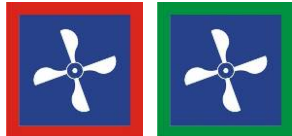


Fig. 1 34 Activation / deactivation of the optional negative pressure unit

To avoid the risk that dust from the contaminated area is dragged into the clean area, all rooms are ventilated. In the contaminated area, air is sucked in and blown out via a HEPA filter. The shower and clean area are also ventilated by air flaps. The air flaps openings have been dimensioned so that there is a pressure drop from the contaminated to the clean area.

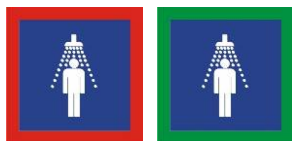


Fig. 1 35 Activation / deactivation of the shower water pump(s)

The shower procedure can only be started and stopped by the switch "start shower procedure" inside the shower.



Fig. 1 36 Activation / deactivation of the STEP BY STEP water heating

The water in the tank is heated to the selected temperature by stepwise filling and heating. This process is repeated until the tank is completely filled. Due to this type of filling, tempered shower water is available after a short time.



Fig. 1 37 Activation / deactivation of the depressurised tank filling via container

When the external water reservoir has been exhausted, the following note will be displayed after approx. 1 minute and the self-priming pump switches off.



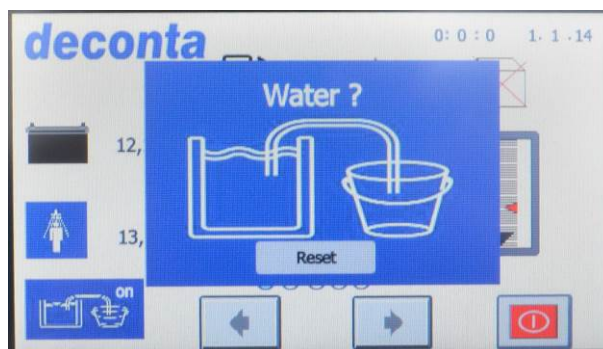


Fig. 1 38 Resetting the pump

If an external water reservoir is available again, the pump can be restarted by pressing the reset button.



Fig. 1 39 Activation / deactivation of the water heating

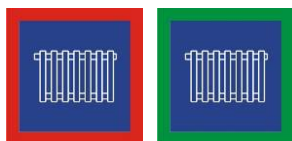


Fig. 1 40 Activation / deactivation of the room heating



Fig. 1 41 Activation / deactivation of the sewage water system

When the switch "shower water start" (inside the shower) is pressed, the sewage pump starts automatically and pumps the contaminated shower water via a 2-stage sewage water system.



Fig. 1 42 Activation / deactivation of the frost protection program

Monitoring the water temperature in the tank, if it's below 5°C, it heats up to 10°C.



Fig. 1 43 Activation / deactivation of the optional cold water function

### 8.2.1.3 Menu page 3

In this menu, further device functions are switched on / off and time-controlled functions are defined. The control remembers these settings so that they are re-activated immediately each time the control is switched on again.

Activated functions are shown with a green frame and deactivated functions are shown with a red frame.

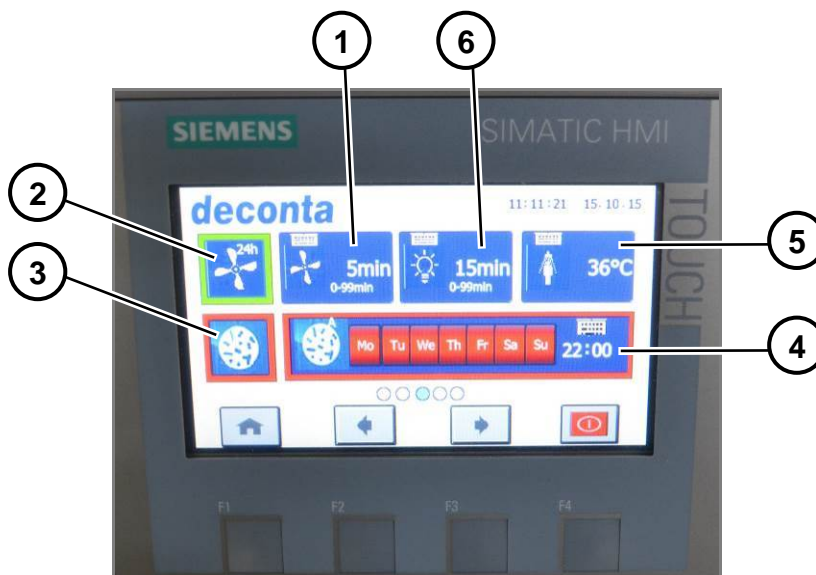


Fig. 1 44 Menu page 3

Pos.	Description
1	Follow-up time negative pressure unit
2	Negative pressure unit continuous operation
3	Sterilisation program
4	Weekly timer for sterilisation program
5	Temperature of shower water
6	Follow-up time light

**Description of the individual menu functions**



Fig. 1 45 Activation / deactivation continuous operation negative pressure unit.



Fig. 1 46 Setting of the time for which the negative pressure unit continues to run after all persons have left the decon unit

Setting of the time for which the negative pressure unit continues to run after all persons have left the decon unit (monitored by motion sensors). By tapping, the following menu appears where time specifications between 0 and 99 minutes are possible. Enter the desired value and confirm with the enter key.



Fig. 1 47 Enter key

Pos.	Description
1	Enter key



Fig. 1 48 Activation / deactivation follow-up time light

Setting of the time the light stays on after all persons have left the Decon unit (monitored by motion sensors). By tapping, the following menu appears where time specifications between 0 and 99 minutes are possible. Enter the desired value and confirm with the enter key.

Operation and control



Fig. 1 49 Enter key

Pos.	Description
1	Enter key



Fig. 1 50 Setting of the shower water temperature

To avoid scalding, the maximum adjustable temperature is limited to 45°C. By tapping, the following menu appears. Enter the desired value and confirm with the enter key.



Fig. 1 51 Enter key

Pos.	Description
1	Enter key



Fig. 1 52 Activation / deactivation sterilisation program

The program starts immediately. The water in the hot water tank is heated up to the maximum achievable temperature for 15 minutes. At least 70°C is recommended to ensure successful sterilisation. The attained temperature is shown on the display after completion. If the temperature is too low, a repeat is recommended. Depending on the outside temperature and the amount of water, the process can take between 5 and 20 hours. To avoid injury from scalding water, the shower function switch is disabled and the supply of shower water is not possible.



Fig. 1 53 Deactivation of sterilisation program



Fig. 1 54 Activation of sterilisation program

The program is started using the time-control function. The water in the shower water tank is heated up to the maximum achievable temperature and held at that maximum temperature for 15 minutes. We recommended heating the stored water to a temperature of at least 70°C to ensure successful sterilisation. The attained temperature is shown on the display panel after completion. If the temperature is too low, we recommend you repeat the process. Depending on the shower tank water start temperature and the amount of water in the tank, the sterilisation process can take from between 5 and 20 hours to complete. To avoid injury from scalding water, the shower function switch is disabled and the supply of shower water is not possible.

By tapping the weekday, the sterilisation program is started on that day, the selected day display changes from red to green.

## Operation and control

By tapping the hour display, the start hour is freely selectable, by tapping the minute display, the start minute is freely selectable. Enter the desired values and confirm with the enter key.



Fig. 1 55 Enter key

Pos.	Description
1	Enter key

## Operation and control

### 8.2.1.4 Menu page 4

In this menu, the weekly timer can be switched on / off and times can be programmed. At the set time, the control is switched on or off with all the basic functions set in the previous menus.

The system time and the system date are also set here.

Activated functions are shown with a green frame and deactivated functions are shown with a red frame.

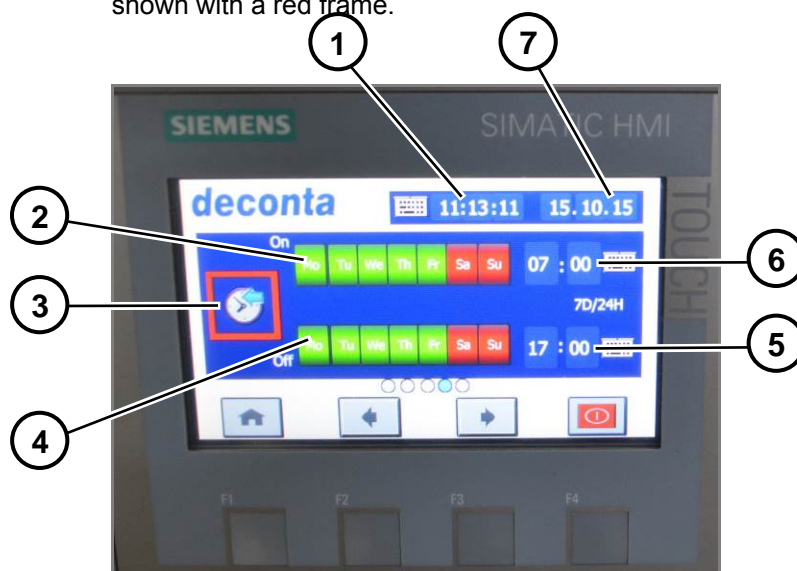


Fig. 1 56 Menu page 4

Pos.	Description
1	System time
2	Weekday on
3	Weekly timer
4	Weekday off
5	Switching time off
6	Switching time on
7	System date

### Description of the individual menu functions

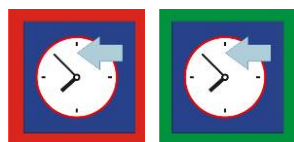


Fig. 1 57 Activation / deactivation of the weekly timer

By tapping the weekday in the "On" line, the control is started on that day at the set switching time indicated at "switching time on", the day display changes from red to green. The switching times and days for switching off the control are set in the "Off" line.

## Operation and control

By tapping the hour display, the start hour is freely selectable, by tapping the minute display, the start minute is freely selectable. Enter the desired values and confirm with the enter key.



Fig. 1 58 Enter key

Pos.	Description
1	Enter key

The system time can be set by tapping hours, minutes and seconds. Enter the desired values and confirm with the enter key.

The system date can be set by tapping the day, month and year. Enter the desired values and confirm with the enter key.



**8.2.1.5 Menu page 5 (only with optional communication module)**

This menu enables the user to define, when selected which warning messages are sent by the communication module to an external mobile phone (via SMS). The messages are sent on the days selected at a scheduled time.

Furthermore, an intruder alarm system can be switched on and off (via motion sensors in the Decon unit).

Activated functions are shown with a green frame and deactivated functions are shown with a red frame.

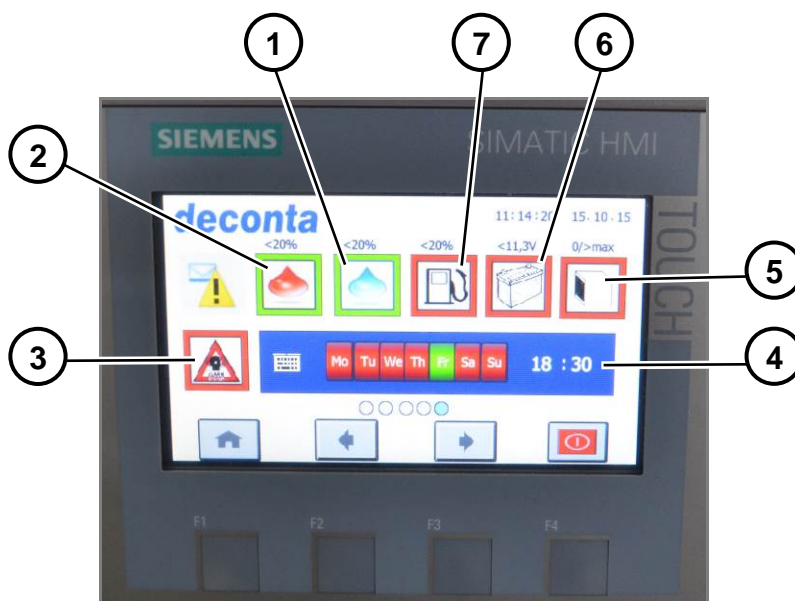


Fig. 1 59 Menu page 5

Pos.	Description
1	Cold water tank
2	Hot water tank
3	Alarm system
4	Time and date setting for messages
5	HEPA-Filter
6	Battery voltage
7	Diesel tank

Description of the individual menu functions

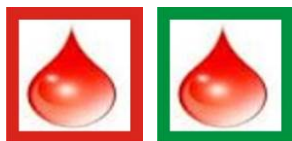


Fig. 1 60 Activation / deactivation of SMS notification  
Filling level of hot water tank below 20%



Fig. 1 61 Activation / deactivation of SMS notification  
Filling level of hot water tank below 20%

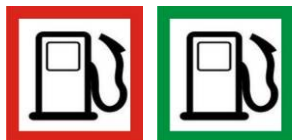


Fig. 1 62 Activation / deactivation of SMS notification  
Filling level of hot water tank below 20%

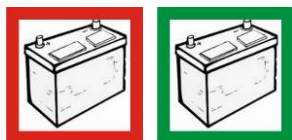


Fig. 1 63 Activation / deactivation of SMS notification  
Battery charging voltage below 11.3 V

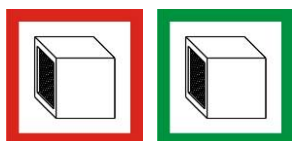


Fig. 1 64 Activation / deactivation of SMS notification HEPA filter  
contaminated or not installed



Fig. 1 65 Selection of days and time

Select the days and the time when an SMS notification should occur.

## Operation and control

The weekday can be selected by tapping, the color changes from red to green. Several or even all days can be selected. If, on these days, one of the previously selected parameters (filling level of hot water tank, filling level of cold water tank, filling level of diesel tank, battery charging voltage, filter) is measured below the set point, an SMS notification occurs at the specified time.

By tapping the hour display, the hour is freely selectable, by tapping the minute display, the minutes are freely selectable. Enter the desired values and confirm with the enter key.



Pos.	Description
1	Enter key



Fig. 1 66 Activation / deactivation of alarm system

The alarm system is switched on by tapping the button. After 5 minutes of activation, the motion sensors register a movement in the Decon Unit and send an alarm message to the external mobile phone.

The alarm system may be switched off only via the external mobile phone.

An activated alarm system is also displayed on the start screen.



Fig. 1 67 Status of the alarm system

Pos.	Description
1	Alarm system display activated

**8.2.2 Functions of the programmable logic smart touch control E-version (electric)**

After switching off the main switch (in the technical room), the following screen is displayed on the operating display in the clean area:



Fig. 1 68 Main screen

Pos.	Description
1	Alarm system display activated
2	Time and date
3	Frost protection display activated
4	On/Off button

Pressing the on / off button starts the control with the last set values.

## Operation and control

### 8.2.2.1 Menu page 1

After switching on, the measured values of the sensors are shown on the display. This is also menu page 1, indicated by the blue dot in the page indicator. The menu page can be switched with the button "next page" and "previous page".

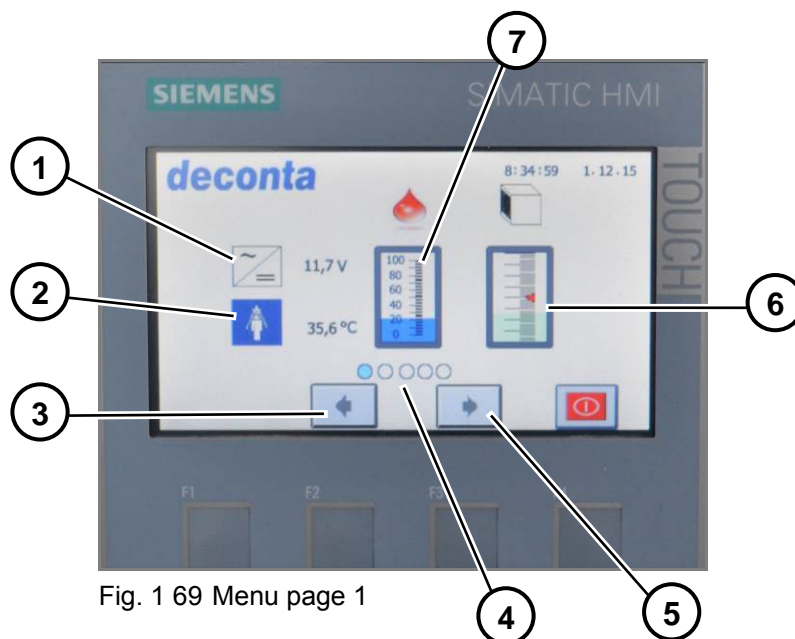


Fig. 1 69 Menu page 1

Pos.	Description
1	12 V operating voltage
2	Temperature of shower water
3	Previous page
4	Page indicator
5	Next page
6	Filter occupancy negative pressure unit
7	Filling level of water tank in %

## Operation and control

### 8.2.2.2 Menu page 2

In this menu, the individual device functions are switched on / off. The control remembers these settings so that they are re-activated immediately each time the control is switched on again.

Activated functions are shown with a green frame and deactivated functions are shown with a red frame.

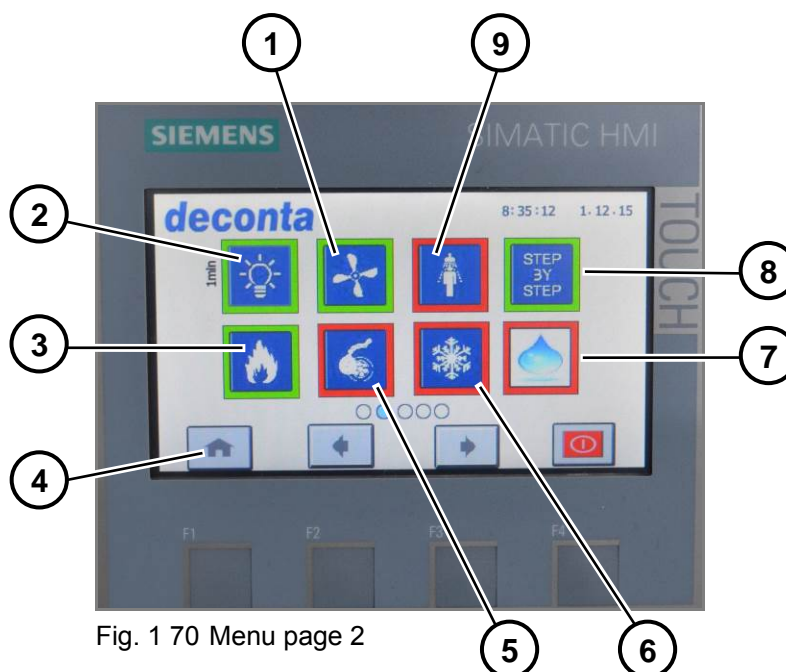


Fig. 1 70 Menu page 2

Pos.	Description
1	Negative pressure (option)
2	Light
3	Burner
4	Home
5	Sewage pump
6	Frost protection
7	Cold water function (option)
8	STEP BY STEP water heating
9	Shower

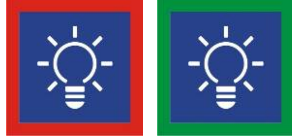
**Description of the individual menu functions**

Fig. 1 71 Activation / deactivation of LED light

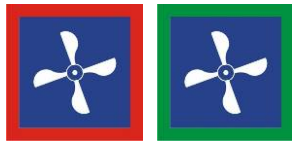


Fig. 1 72 Activation / deactivation of the optional negative pressure unit

To avoid the risk that dust from the contaminated area is dragged into the clean area, all rooms are ventilated. In the contaminated area, air is sucked in and blown out via a HEPA filter. The shower and clean area are also ventilated by air flaps. The air flaps openings have been dimensioned so that there is a pressure drop from the contaminated to the clean area.



Fig. 1 73 Activation / deactivation of the shower water pump(s)

The shower procedure can only be started and stopped by the switch "start shower procedure" inside the shower.



Fig. 1 74 Activation / deactivation of the water heating



Fig. 1 75 Activation / deactivation of the STEP BY STEP water heating

The water in the tank is heated to the selected temperature by stepwise filling and heating. This process is repeated until the tank is completely filled. Due to this type of filling, tempered shower water is available after a short time.





Fig. 1 76 Activation / deactivation of the sewage water system

When the switch "shower water start" (inside the shower) is pressed, the sewage pump starts automatically and pumps the contaminated shower water via a 2-stage sewage water system.



Fig. 1 77 Activation / deactivation of the frost protection program

Monitoring the water temperature in the tank, if it's below 5°C, it heats up to 10°C.

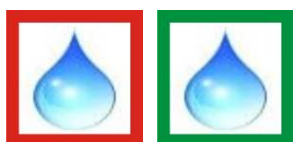


Fig. 1 78 Activation / deactivation of the optional cold water function

8.2.2.3 Menu page 3

In this menu, further device functions are switched on / off and time-controlled functions are defined. The control remembers these settings so that they are re-activated immediately each time the control is switched on again.

Activated functions are shown with a green frame and deactivated functions are shown with a red frame.

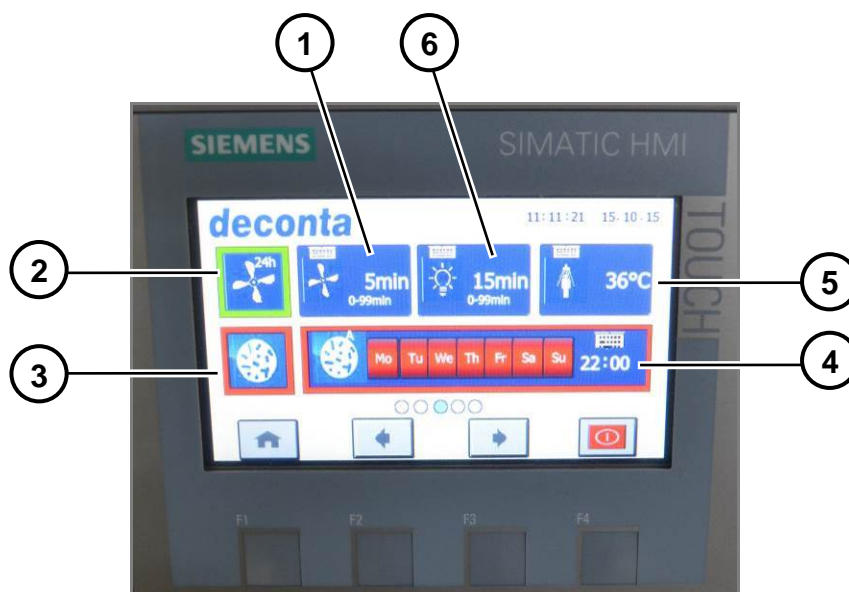


Fig. 1 79 Menu page 3

Pos.	Description
1	Follow-up time negative pressure unit
2	Negative pressure unit continuous operation
3	Sterilisation program
4	Weekly timer for sterilisation program
5	Temperature of shower water
6	Follow-up time light

**Description of the individual menu functions**



Fig. 1 80 Activation / deactivation continuous operation negative pressure unit.



Fig. 1 81 Follow-up time

Setting of the time for which the negative pressure unit continues to run after all persons have left the decon unit (monitored by motion sensors). By tapping, the following menu appears where time specifications between 0 and 99 minutes are possible. Enter the desired value and confirm with the enter key.



Fig. 1 82 Entry menu

Pos.	Description
1	Enter key

Operation and control



Fig. 1 83 Activation / deactivation follow-up time light

Setting of the time the light stays on after all persons have left the Decon unit (monitored by motion sensors). By tapping, the following menu appears where time specifications between 0 and 99 minutes are possible. Enter the desired value and confirm with the enter key.



Fig. 1 84 Entry menu

Pos.	Description
1	Enter key

Operation and control



Fig. 1 85 Setting of the shower water temperature

To avoid scalding, the maximum adjustable temperature is limited to 45°C. By tapping, the following menu appears. Enter the desired value and confirm with the enter key.



Fig. 1 86 Entry menu

Pos.	Description
1	Enter key



Fig. 1 87 Activation / deactivation sterilisation program

The program starts immediatly. The water in the shower water tank is heated up to the maximum achievable temperature and held at the that maximum temperature for 15 minutes. We recommended heating the stored water to a temperature of at least 70°C to ensure successful sterilisation. The attained temperature is shown on the display panel after completion. If the temperature is too low, we recommend you repeat the process. Depending on the shower tank water start temperature and the amount of water in the tank, the steralisation process can take from between 5 and 20 hours to complete. To avoid injury from scalding water, the shower function switch is disabled and the supply of shower water is not possible.

Operation and control

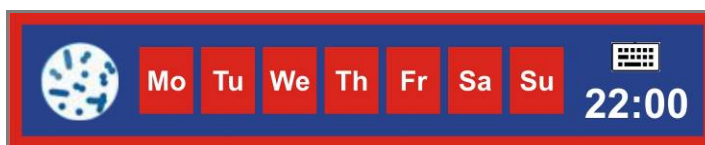


Fig. 1 88 Deactivation of sterilisation program



Fig. 1 89 Activation of sterilisation program

The program is started using the time-control function. The water in the shower water tank is heated up to the maximum achievable temperature and held at the that maximum temperature for 15 minutes. We recommended heating the stored water to a temperature of at least 70°C to ensure successful sterilisation. The attained temperature is shown on the display panel after completion. If the temperature is too low, we recommend you repeat the process. Depending on the shower tank water start temperature and the amount of water in the tank, the sterilisation process can take from between 5 and 20 hours to complete. To avoid injury from scalding water, the shower function switch is disabled and the supply of shower water is not possible.

By tapping the weekday, the sterilisation program is started on this day, the day display changes from red to green.

By tapping the hour display, the start hour is freely selectable, by tapping the minute display, the start minute is freely selectable. Enter the desired values and confirm with the enter key.



Fig. 1 90 Enter key

Pos.	Description
1	Enter key

## Operation and control

### 8.2.2.4 Menu page 4

In this menu, the weekly timer can be switched on / off and times can be programmed. At the set time, the control is switched on or off with all the basic functions set in the previous menus.

The system time and the system date are also set here.

Activated functions are shown with a green frame and deactivated functions are shown with a red frame.

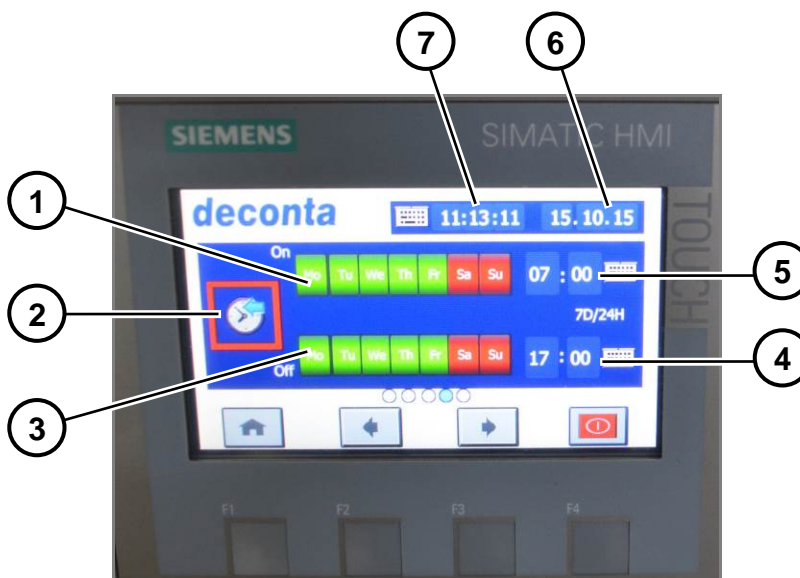


Fig. 1 91 Menu page 4

Pos.	Description
1	Weekday on
2	Weekly timer
3	Weekday off
4	Switching time off
5	Switching time on
6	System date
7	System time

**Description of the individual menu functions**

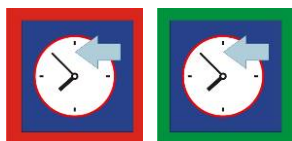


Fig. 1 92 Activation / deactivation of the weekly timer

By tapping the weekday in the "On" line, the control is started on that day at the set switching time indicated at "switching time on", the day display changes from red to green. The switching times and days for switching off the control are set in the "Off" line.

By tapping the hour display, the hour is freely selectable, by tapping the minute display, the minutes are freely selectable. Enter the desired values and confirm with the enter key.



Fig. 1 93 Entry menu

Pos.	Description
1	Enter key

The system time can be set by tapping hours, minutes and seconds. Enter the desired values and confirm with the enter key.

The system date can be set by tapping the day, month and year. Enter the desired values and confirm with the enter key.



**8.2.2.5 Menu page 5 (only with optional communication module)**

This menu enables the user to define, when selected which warning messages are sent by the communication module to an external mobile phone (via SMS). The messages are sent on the days selected at a scheduled time.

Furthermore, an intruder alarm system can be switched on and off (via motion sensors in the Decon unit).

Activated functions are shown with a green frame and deactivated functions are shown with a red frame.

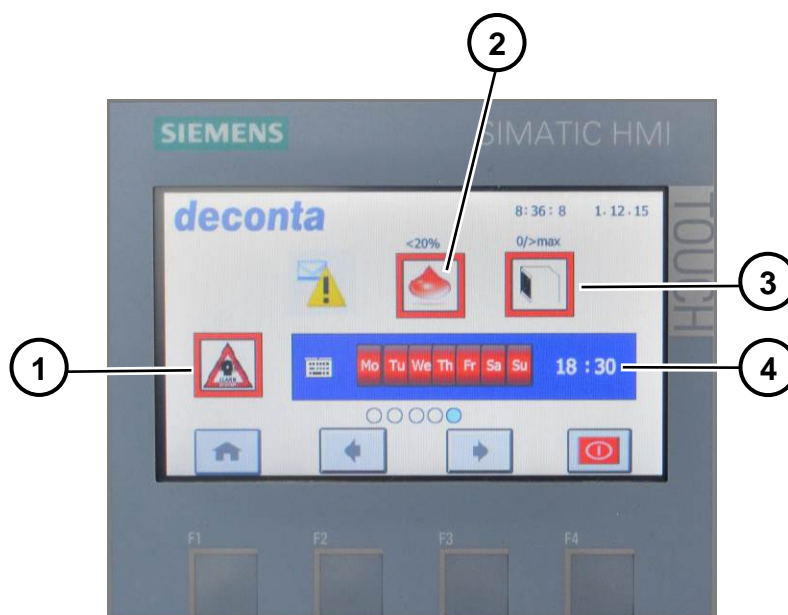


Fig. 1 94 Menu page 5

Pos.	Description
1	Alarm system
2	Water tank
3	HEPA-Filter
4	Time and date setting for messages

**Description of the individual menu functions**

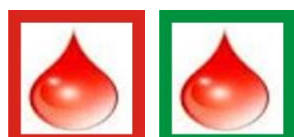


Fig. 1 95 Activation / deactivation of SMS notification  
Filling level of hot water tank below 20%

Operation and control

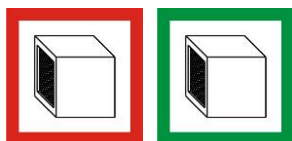


Fig. 1 96 Activation / deactivation of SMS notification HEPA filter contaminated or not installed



Fig. 1 97 Selection of days and time when an SMS notification should occur

The weekday can be selected by tapping, the color changes from red to green. Several or even all days can be selected. If, on these days, one of the previously selected parameters (filling level of hot water tank, filling level of cold water tank, filling level of diesel tank, battery charging voltage, filter) is measured below the set point, an SMS notification occurs at the specified time.

By tapping the hour display, the hour is freely selectable, by tapping the minute display, the minutes are freely selectable. Enter the desired values and confirm with the enter key.



Fig. 1 98 Entry menu

Pos.	Description
1	Enter key

Operation and control



Fig. 1 99 Activation / deactivation of alarm system

The alarm system is switched on by tapping the button. After 5 minutes of activation, the motion sensors register a movement in the Decon Unit and send an alarm message to the external mobile phone.

The alarm system may be switched off only via the external mobile phone.

An activated alarm system is also displayed on the start screen.



Fig. 1 100 Alarm system display activated

Pos.	Description
1	Alarm system display activated

**8.2.3 Communication module (Option)**

The communication module is located in the technical room. The mobile app can be used to control, interrogate and monitor different functions remotely.

The module requires a Mini Sim card (standard sim) for data exchange

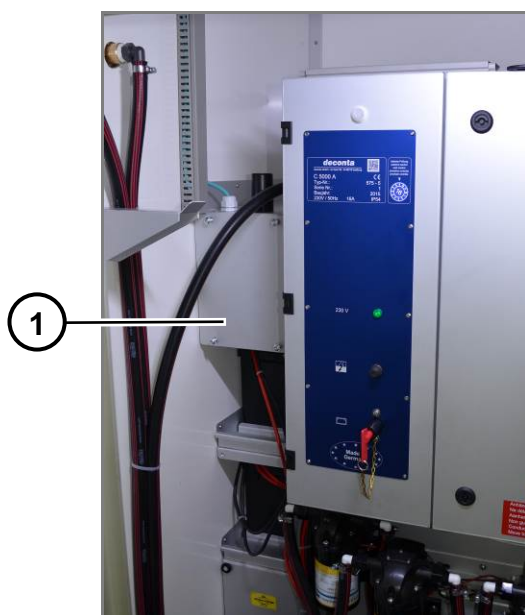


Fig. 1 101 Outer view of the communication module

Pos.	Description
1	Communication module

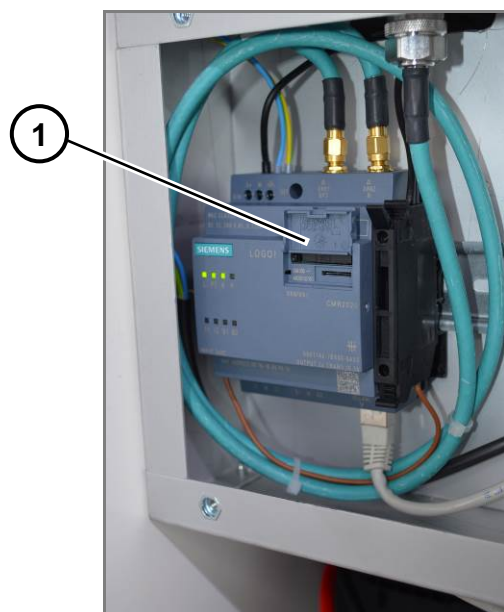


Fig. 1 102 Inner view of communication module

Pos.	Description
1	Mini sim card

**8.2.3.1 Mobile app autarkic version**

The following display is shown after starting the app:

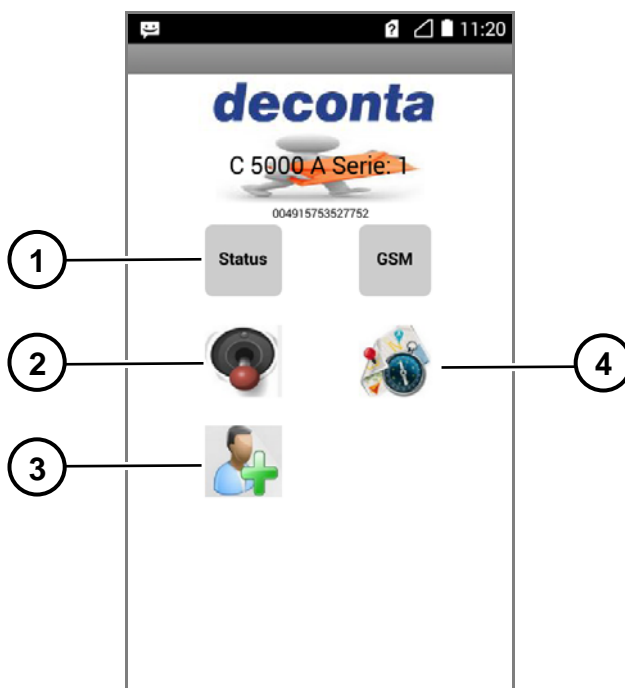


Fig. 1 103 Mobile app autarkic version

Pos.	Description
1	Status request
2	Remote control
3	User management
4	GPS - tracking

**Menu status request**

The menu opens by briefly pressing the “Status” button. By prolonged pressing, it closes.

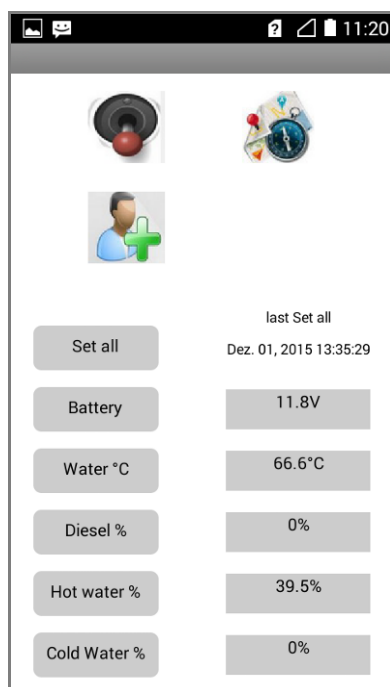


Fig. 1 104 Menu status request

By tapping the individual button, the current measured values of the sensors in the deco mobil can be interrogated.

Set all	all values are interrogated
Battery	the charging voltage of the batteries is interrogated
Water °C	the shower water temperature is interrogated
Diesel %	the filling level of the diesel tank is interrogated
Hot water %	the filling level of the hot water tank is interrogated
Cold water %	the filling level of the cold water tank is interrogated

(Option)

After a short time, the current values are displayed in the right column.

**Menu Remote control**

The menu opens by briefly pressing the “remote control” button. By prolonged pressing, it closes. By prolonged pressing, it closes.

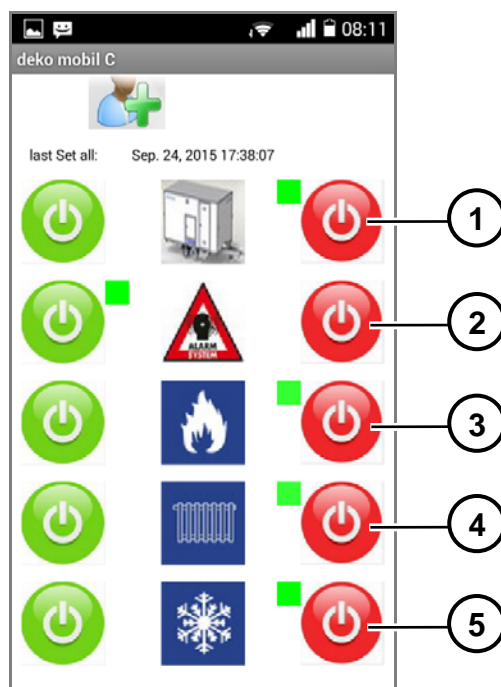


Fig. 1 105 Menu Remote control

Pos.	Description
1	Control ON/OFF
2	Alarm system ON/OFF
3	Burner ON/OFF
4	Heating ON/OFF
5	Frost protection program ON/OFF

By tapping the green button, individual functions are switched on, by tapping the red button, they're switched off.

The switching states are indicated by a green square next to the respective button.



**Menu GPS - tracking**

The menu opens by briefly pressing the “GPS tracking” button. By prolonged pressing, it closes. By prolonged pressing, it closes.

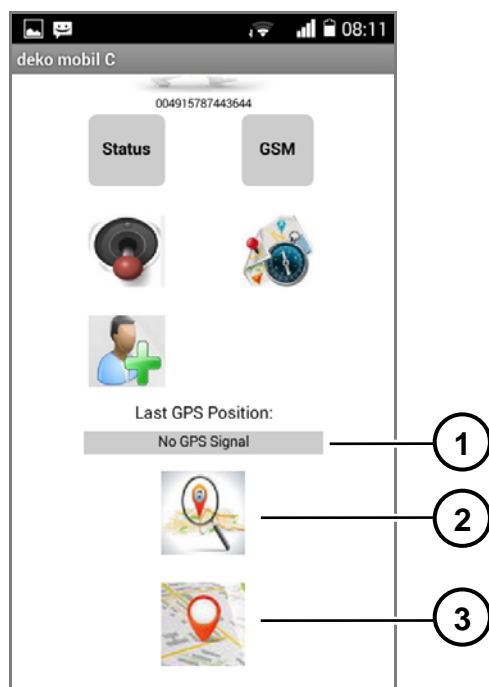


Fig. 1 106 Menu GPS - tracking

Pos.	Description
1	GPS data display
2	Interrogate GPS data
3	Map

By pressing the button "interrogate GPS data", the position coordinates are sent by the communication module in the Decon unit to the mobile phone app and are displayed there.

By pressing the “map” button, the position is shown on a Google Maps map.

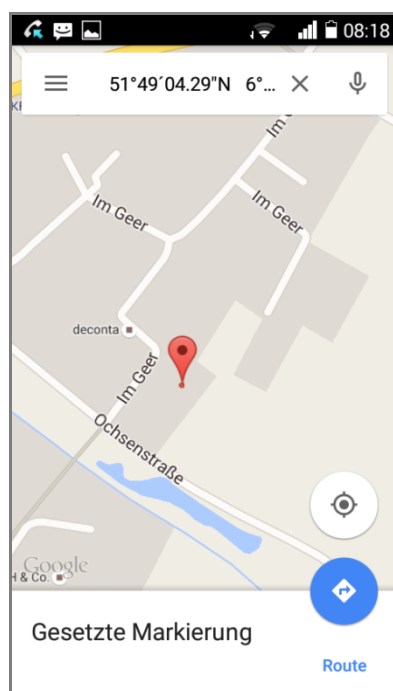


Fig. 1 107 Google Maps map view

**Menu User management**

The menu opens by briefly pressing the “user management” button. By prolonged pressing, it closes.

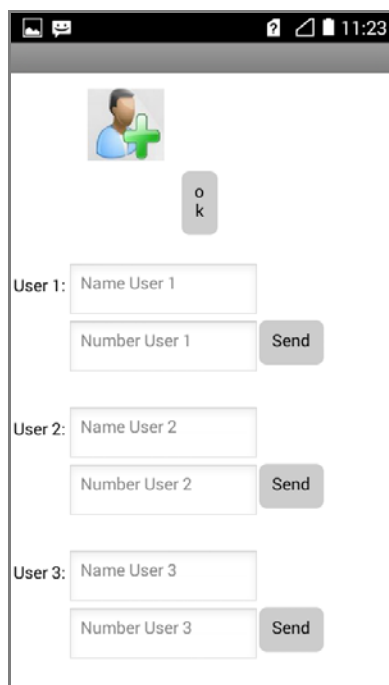


Fig. 1 108 Menu User management

## Operation and control

---

By entering the password in the delivery status admin, a submenu opens, in which new users can be created. They will also receive the SMS warning messages sent by the deco mobil.



The screenshot shows a mobile application interface for creating users. At the top, there is a status bar with the time 11:23. Below the status bar, there is a header area with a user profile icon and a green plus sign. A small dialog box with the text 'o k' is visible. The main content area contains three user creation forms, each labeled 'User 1:', 'User 2:', and 'User 3:'. Each form has two input fields: 'Name User X' and 'Number User X', followed by a 'Send' button.

Fig. 1 109 Sub-menu - Create users

Examples of alarm messages on the mobile phone:



Fig. 1 110 Warning message Filling level of cold water tank below 20%



Fig. 1 111 Warning message alarm system has been triggered

**8.2.3.2 Mobile app electric version**

The following display is shown after starting the app:

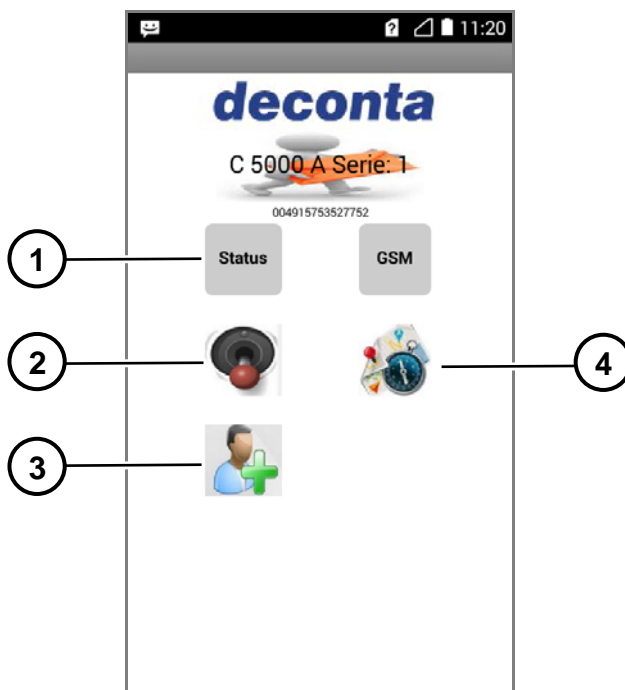


Fig. 1 112 Mobile app electric version

Pos.	Description
1	Status request
2	Remote control
3	User management
4	GPS - tracking

**Menu status request**

The menu opens by briefly pressing the “Status” button. By prolonged pressing, it closes.



Fig. 1 113 Menu status request

By tapping the individual button, the current measured values of the sensors in the deco mobil can be interrogated.

Set all	all values are interrogated
Battery	the 12-volt system voltage is interrogated
Water °C	the shower water temperature is interrogated
Hot water %	the filling level of the hot water tank is interrogated

After a short time, the current values are displayed in the right column.

**Menu Remote control**

The menu opens by briefly pressing the “remote control” button. By prolonged pressing, it closes.

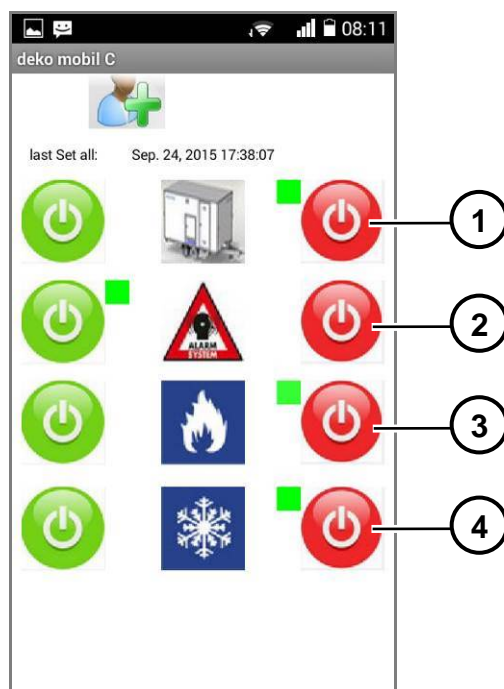


Fig. 1 114 Menu Remote control

Pos.	Description
1	Control ON/OFF
2	Alarm system ON/OFF
3	Water heating ON/OFF
4	Frost protection program ON/OFF

By tapping the green button, individual functions are switched on, by tapping the red button, they're switched off.

The switching states are indicated by a green square next to the respective button.



**Menu GPS - tracking**

The menu opens by briefly pressing the “GPS tracking” button. By prolonged pressing, it closes. By prolonged pressing, it closes.

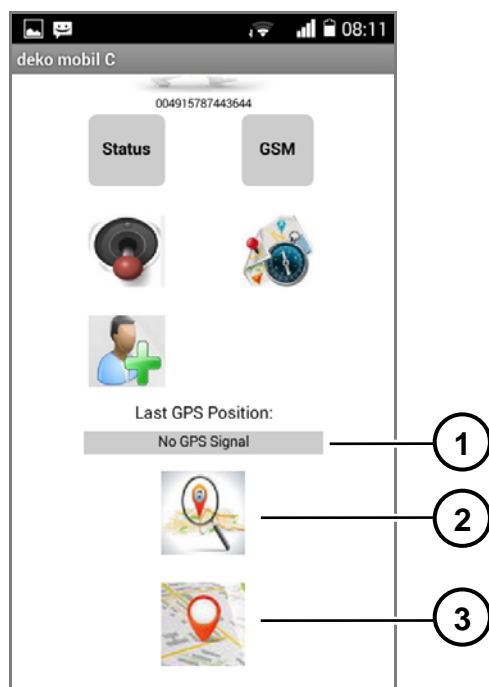


Fig. 1 115 Menu GPS - tracking

Pos.	Description
1	GPS data display
2	Interrogate GPS data
3	Map

By pressing the button "interrogate GPS data", the position coordinates are sent by the communication module in the Decon unit to the mobile phone app and are displayed there.

## Operation and control

---

Fig. 1 116

By pressing the “map” button, the position is shown on a Google Maps map.

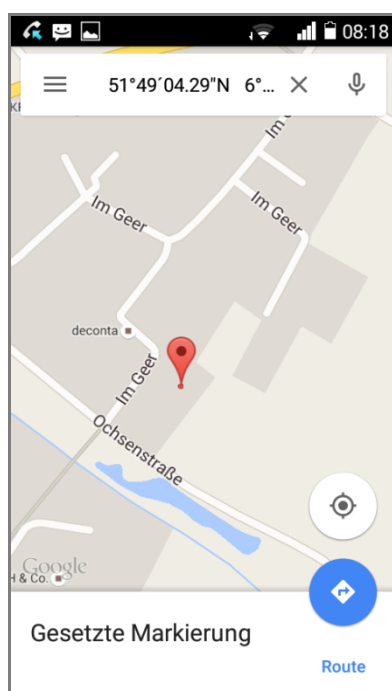


Fig. 1 117 Google Maps map view

### Menu User management

The menu opens by briefly pressing the “user management” button. By prolonged pressing, it closes.

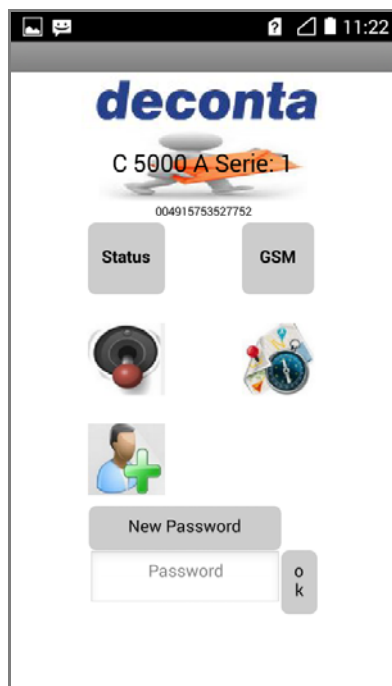
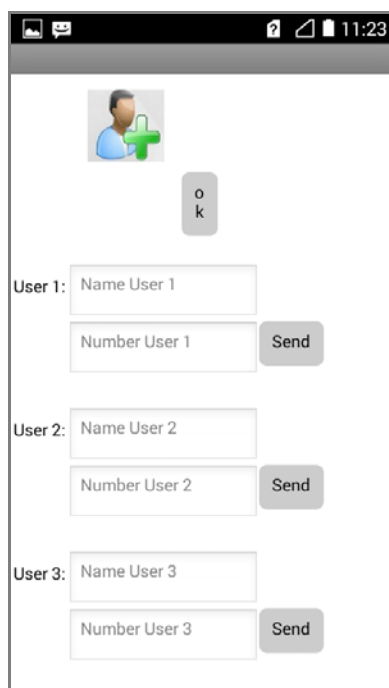


Fig. 1 118 Menu User management

## Operation and control

---

By entering the password in the delivery status admin, a submenu opens, in which new users can be created. They will also receive the SMS warning messages sent by the deco mobil.



The screenshot shows a mobile application interface for creating users. At the top, there is a status bar with the time 11:23. Below the status bar, there is a profile picture of a person with a green plus sign. A grey button labeled 'ok' is positioned below the profile picture. The main content area contains three user creation forms, each labeled 'User 1:', 'User 2:', and 'User 3:'. Each form consists of two input fields: 'Name User 1', 'Number User 1', 'Name User 2', 'Number User 2', 'Name User 3', and 'Number User 3'. A grey 'Send' button is located to the right of each 'Number' input field.

Fig. 1 119 Sub-menu - Create users

Examples of alarm messages on the mobile phone:



Fig. 1 120 Warning message Filling level of cold water tank below 20%

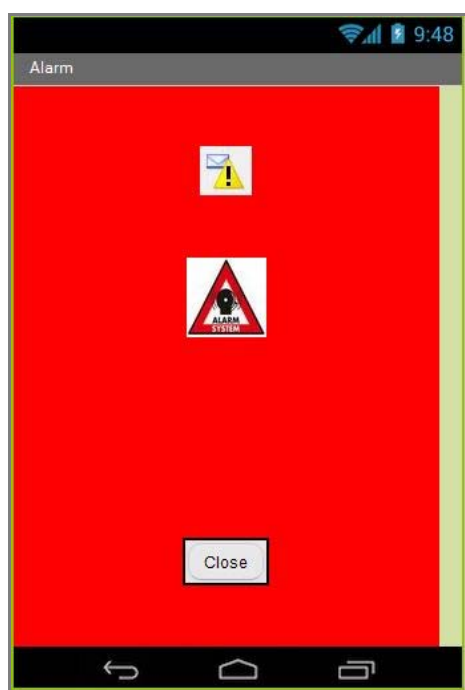


Fig. 1 121 Warning message alarm system has been triggered

### **8.3 Control**

#### **8.3.1 Power on and Power off**

##### **Power on**

Proceed as follows:

- switch on the main switch on the control cabinet,
- press the Control ON/OFF button on the operating display.

##### **Power off**

Proceed as follows in order to avoid damages:

- press the Control ON/OFF button on the operating display,
- Wait a minimum of five minutes before turning off the main switch on the control cabinet. This will allow the unspent fuel in the webasto to be processed prior to the webasto burner turning off.

**8.4 Other options**

**8.4.1 Connection of all chambers to the sewage water filtration system**



Fig. 1 122 Connections of chambers 1-3 to the sewage water filtration system



Fig. 1 123 Connections of chambers 4-6 to the sewage water filtration system

In the shower chambers, the ball valves marked with 1 to 6 can be selected, in which chamber water is pumped out via the sewage water filtration system.

**It is extremely important to ensure that only one ball cock is opened in each shower chamber.**

Position the ball valve vertically → Water is pumped from the shower chamber

Position the ball valve horizontally → Water is pumped from the shower chamber

**8.4.2 Compressed air system for respirators**

Fig. 1 124 Compressed air feed



Fig. 1 125 Compressed air supply

There are 2 connections for respirators with compressed air system in all chambers. External feed is supplied externally to the vehicle.



#### 8.4.3 Switchable socket and hose connection for vacuum cleaner (ATTIX 30)

(only in conjunction with additional chamber for vacuum cleaner / waste system with door to the outside)



Fig. 1 126 Vacuum cleaner connection in additional chamber

#### Please note!

**The blue 230 V socket works only when the vehicle is connected to an external power supply. It does not work in autarkic operation!**



Fig. 1 127 Additional chamber with vacuum cleaner

Remove the yellow lid, connect the hose of the vacuum cleaner and secure with a hose clamp. Plug the mains cable of the vacuum cleaner into the blue socket and switch on the vacuum cleaner.

The vacuum cleaner can be securely fixed by means of a tensioning strap.



Fig. 1 128 Vacuum cleaner connection



Fig. 1 129 Vacuum cleaner hose

In the contaminated chamber, remove the yellow lid, connect the hose of the vacuum cleaner and secure with a hose clamp.

The vacuum cleaner can be started now by pressing the button. Long-pressing (approx. 5 seconds) stops the vacuum process.

## 9 Faults

The specialised staff will eliminate the faults in the machine.

→ Observe the information about the faults and their rectification in the documents of chapter 12 .

### 9.1 Fault reports on the operating display

States (ON / OFF) or filling levels only are indicated on the display.

### 9.2 Faults without fault reports

Faults	Potential causes	Rectification
Failure to start pumps	Defective fuse, defective engine	By specialised staff
Control cannot be switched on	No supply voltage, defective wire	By specialised staff

→ When the water heating is activated, make sure that the diesel tank is filled adequately. Due to the hose length from the diesel tank to the warm water generator, it is possible that adequate diesel is not supplied to the burner. The warm water generator switches off again (observe running noises). In this case, switch off the water heating and switch it on again after approx. 1 minute. Repeat this process 2 - 3 times as required.

## **10 Maintenance**

### **10.1 Maintenance plan**

The machine is maintained according to the maintenance plan.

Perform regular inspections of the:

- protective conductor system,
- earthing,
- housing,
- label of the operating elements.

#### **10.1.1 Filter change sewage filter**

- Filter change only when the device is switched off,
- Remove contaminated filters in moist state to prevent filter dust release,
- use approved filters only,
- damaged filter candles must not be used.

The sewage water filters must be changed if the capacity of the sewage pump decreases. We recommend a weekly change for normal volume of sewage water and a daily change for heavy strain.

- Loosen union nut with filter key,
- Remove and dispose filter
- Ensure that the filter glass and the sealing surface are clean
- Insert new filter candles,
- Tighten the union nut hand tight.

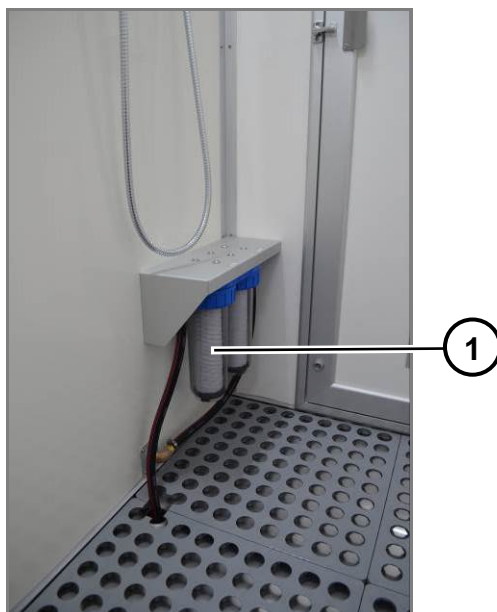


Fig. 1 130 Sewage filter

Pos.	Description
1	Sewage filter

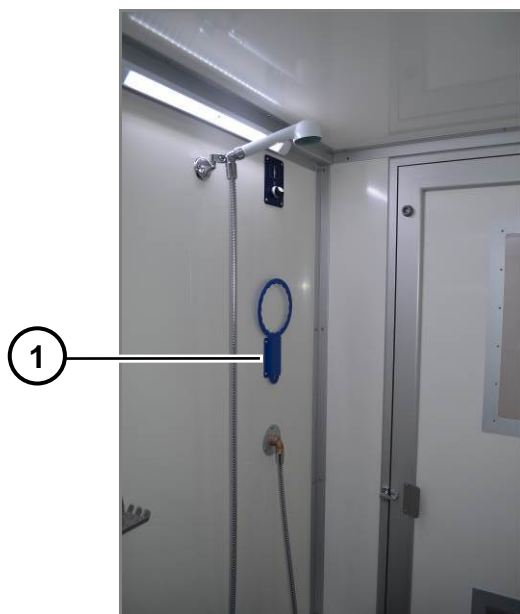


Fig. 1 131 Filter key

Pos.	Description
1	Filter key



**WARNING**

Suction hoses, pumps, filter housings and filters are already contaminated by the first use. Repairs and maintenance may be carried out only in compliance with all relevant safety precautions.

- All filters mentioned here must be disposed in accordance with the legal requirements.

**10.1.2 Filter change HEPA-Filter**



**ATTENTION**

Contaminated filters must be changed only in compliance with all relevant safety precautions.

- Wear PPE,
- Filter change only when the device is switched off,
- use approved filters only,
- Do not use residual fibre bonding agents on the device

A necessary filter change is indicated on the display of the smart touch control and should be done when the red Max-arrow is reached.

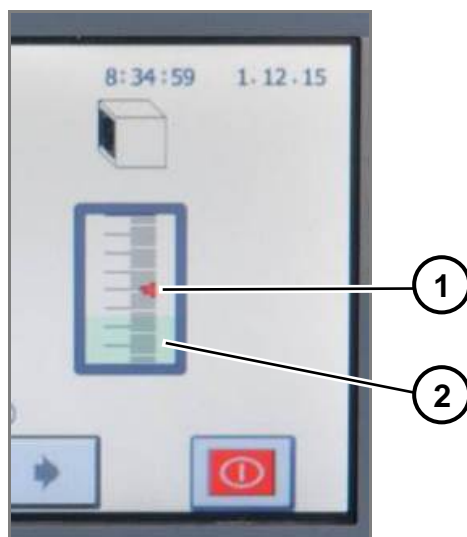


Fig. 1 132 Filling level indicator

Pos.	Description
1	Max-arrow
2	Filter occupancy negative pressure unit

**10.1.2.1 Remove filter**

→ Unscrew the hexagon socket screws with the hex wrench and remove the tenter.

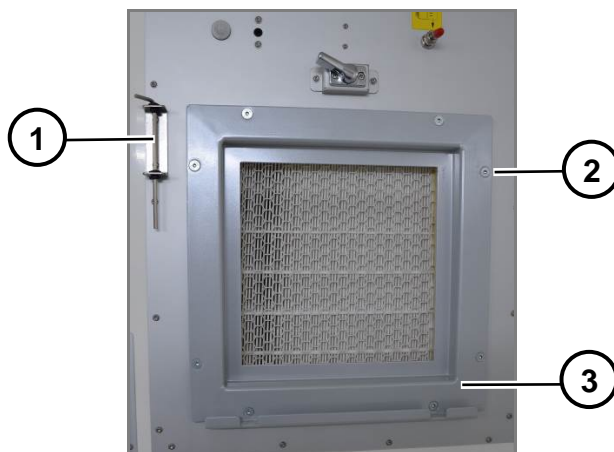


Fig. 1 133 Filter cover

Pos.	Description
1	Hex wrench
2	Hexagon socket screw
3	Tenter

→ Remove and dispose filter.

**10.1.2.2 Insert new filter:**

- Check and clean the sealing surfaces of the device,
- clean the housing on the inside,
- insert new filter in the centre,
- Insert the tenter and hexagon socket screws (tighten the screws evenly)



**WARNING**

Treat the HEPA filter carefully as damage can annul the effectiveness of the filtration.

**10.1.2.3 Version with electrically closing filter cover**

In order to reach the tenter of the HEPA filter, the electrically closing filter cover must be disassembled in the first instance.

- Disconnect the power connection,
- Loosen the tension locks,
- Remove the filter cover.

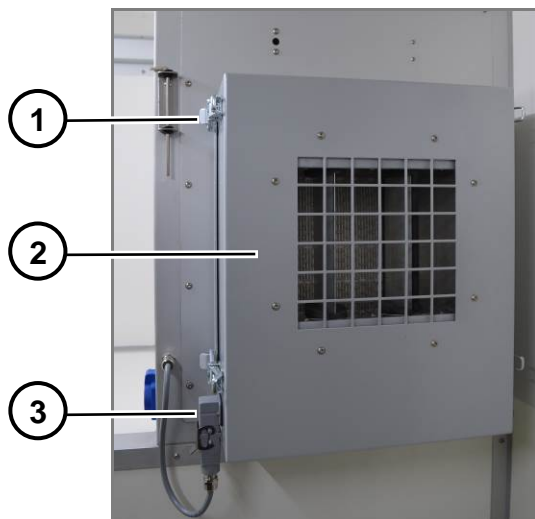


Fig. 1 134 Electrically closing filter cover

Pos.	Description
1	Tension lock
2	Filter cover
3	Power connection

- Make the actual filter change as described above.



## Maintenance

### 10.1.3 Sterilisation program

For hygienic reasons, we recommend to start the sterilisation program at least twice a week.

### 10.1.4 Shower hose

For hygienic reasons, we recommend to renew the shower hose at least once a year.

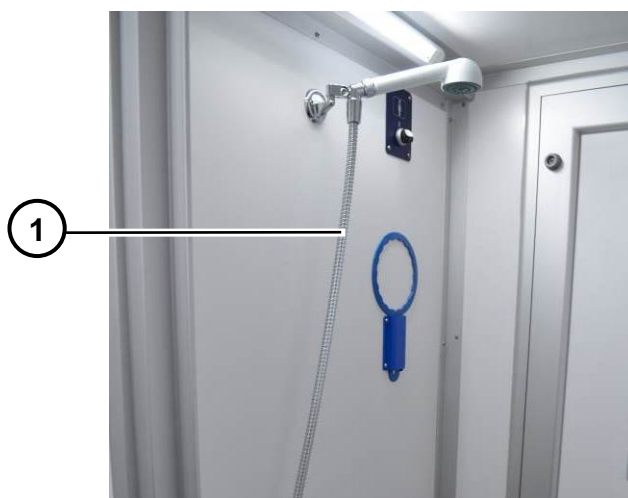


Fig. 1 135 Shower hose

Pos.	Description
1	Shower hose

## 10.2 Repair

Adopt repair measures in consultation with the manufacturing company.

→ Follow the information in the non-company documentation in chapter 12.1 .

## 10.3 Safety-related components

→ Replace the safety-related components regularly before the end of the service life. The service life is stated by the manufacturer.

→ Observe the information given in the bill of material of the machine and in the non-company documentation.

## 10.4 Inspections

→ Inspect the machine according to the information in the chapter Commissioning.

## **11 Decommissioning and Disassembly**

### **11.1 Decommissioning**

During decommissioning, the functionality of the machine will be:

- interrupted for an indefinite period or
- interrupted for a longer period with the result that the maintenance work is not carried out by the operator as per the maintenance plan and other surveillance measures.

The following measures are required:

- Disconnect and interrupt the energy inputs,
- prevent the unauthorised persons from retrieving the energy input,
- check whether liquids and fuels are removed or need to be replaced,
- Secure the machine against unwanted movements,
- where required, prevent dirt caused by debris,
- perform regular visual inspection.

#### **Stability**

- Do not loosen the fastening on the ground,
- Bracing and stabilisation of racks and machine parts obtained.

### **11.2 Disassembly and Storage**

- Observe the non-company documentation in chapter 12.1 .

#### **11.2.1 Prepare machine and components**

- Protect sensitive surface against damages,
- Pack the machine or machine parts if required,
- prevent vermin infestation.

## **Decommissioning and Disassembly**

---

### **11.2.2 Storage**

#### **Storage conditions**

The storage location must fulfill the following conditions:

- dry,
- weatherproof,
- adequate strength of the ground,
- low dust generation.

#### **Stability**

Store the machine parts such that they:

- do not tip,
- do not slip, fall over and fall down,
- do not lose their shape or can warp.

If the storage conditions are not met, components may corrode or age prematurely. The serviceable life of the system is shortened. The service life of the system is degraded.

### **11.2.3 Inspect stored goods**

Unforeseeable events may occur during storage. These include:

- Effects of the weather,
- Damages to property,
- Vermin infestation,
- Negligence during warehousing.

Damages may prevail on the machine or the machine components.

→ Check the location, packaging and the general condition of the storage parts at regular intervals.

### **11.3 Re-commissioning**

During re-commissioning, the functionality of the machine is reproduced after prolonged decommissioning.

→ Proceed as described in the chapter Commissioning.

**11.4 Disassembly and disposal**

The machine contains components or substances that endanger the environment if not used properly.

Accumulators in:

- Technical room

Filter in:

- Sewage filter,
- Negative pressure unit.

Fuels in:

- Diesel tank of autarkic version, max. 25 litres.

## 12 Attachments

### 12.1 Non-company documentation

Name of the machine part	Manufacturer	Name of the document manufacturer	Date of the document
Thermo Top	Webasto	Operating instructions	03/11
Pressure sensor	freescala	Data sheet	01/2009
Simatic HMI KTP400 Basic	Siemens	Data sheet	06/2017
Drawbar	AL-KO	Company standard	02/00
Drawbar	AL-KO	Assembly and instruction manual	06/2010
Axle braked	AL-KO	Data sheet	
Drawbar installation profiles	AL-KO	Data sheet	
Leg supports are rotatable	AL-KO	Data sheet	
Clamps for support wheels	AL-KO	Data sheet	
Support wheels	AL-KO	Data sheet	
Wheel rim	Vlukon	Payload confirmation	01/2014

### 12.2 Own documentation

Description	Identification
Name deco mobil C ECO 3000	PS1302 571-3 ECO 3000 A-Version.jpg
Drawing of deco mobil C 4000	PS1295 573-4 C 4000.JPG
Drawing of deco mobil C 5000	575-5 C 5000 Frankreich 3D.JPG
Circuit diagram A-version	Circuit diagram A-version.pdf
Circuit diagram E-version	Circuit diagram E-version.pdf
Circuit diagram of vehicle lighting	Circuit diagram of vehicle lighting.pdf
List of spare parts	Equipment and options

#### Safety-related spare parts

The chapter contains the specifications of the spare parts to be used, which affect the safety and health of the staff.

- Follow the bill of material in chapter 12.2, 12.2 .
- Follow the information in the non-company documentation in chapter 12.1 .

**12.3 Suppliers of special tools, materials, professional help**

<b>Tool, material, professional help</b>	<b>Supplier</b>
Drawbar Drawbar Axle braked Drawbar installation profiles Leg supports are rotatable Clamps for support wheels Support wheels	Company AL-KO
Thermo Top	Webasto
Simatic HMI KTP400 Basic	Siemens

## 12.4 Operating time in battery power

The operating time of the battery can be calculated using the following data, and the result can only be approximated since the operating time also depends on other factors such as ambient temperature, charge state and age of the battery.

Battery capacity at full charge: 190 Ah

Current consumption of the consumers:

• Control	1.30 A
• Fan, room heating	0.30 A
• Lighting	4.50 A
• Negative pressurisation 225 m <sup>3</sup> /h	3.65 A
• Negative pressurisation 450 m <sup>3</sup> /h	7.30 A
• Fresh water pump	3.80 A
• Sewage pump	3.80 A
• Burner full load	4.00 A
• Burner partial load	2.50 A

The hourly energy requirement is calculated by the consumption of electricity of the consumers multiplied by their duration in hours. The operating time of the battery can be calculated from the hourly energy requirement.

Example:

- Lighting, in operation at the start of work,  
End, break and when using the shower,  
approx. 12 min/h = 0.20 h x 4.5 A = 0.90 Ah
- Control, in continuous operation = 1.00 h x 1.3 A = 1.30 Ah
- Negative pressurisation 225 m<sup>3</sup>/h,  
in continuous operation = 1.00 h x 7.3 A = 3.80 Ah
- Shower / sewage pump, in shower time of  
1 min and 12 showers in 2 hours  
approx. 6 min/h = 0.10 h x 7.6 A = 0.76 Ah
- Burner full load, for heating of the shower water  
approx. 45 min/h = 0.75 h x 4.0 A = 3.00 Ah
- Burner partial load, for room heating  
approx. 15 min/h = 0.25 h x 2.8 A = 0.70 Ah

**Attachments**

---

hourly power requirement	10.46 Ah
Capacity of the batteries	190 Ah
Theoretical operating time until complete emptying	$190\text{Ah} / 10.46\text{Ah} = 18 \text{ h}$



## 12.5 Identification plate

deco mobil C ECO 3000

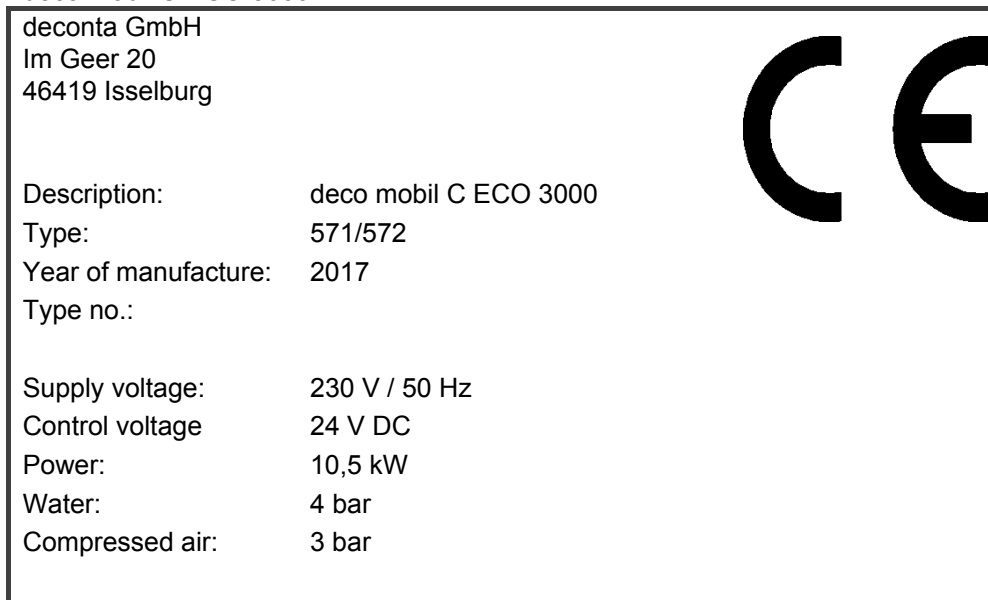


Fig. 1 136 Identification plate deco mobil C ECO 3000

deco mobil C 4000

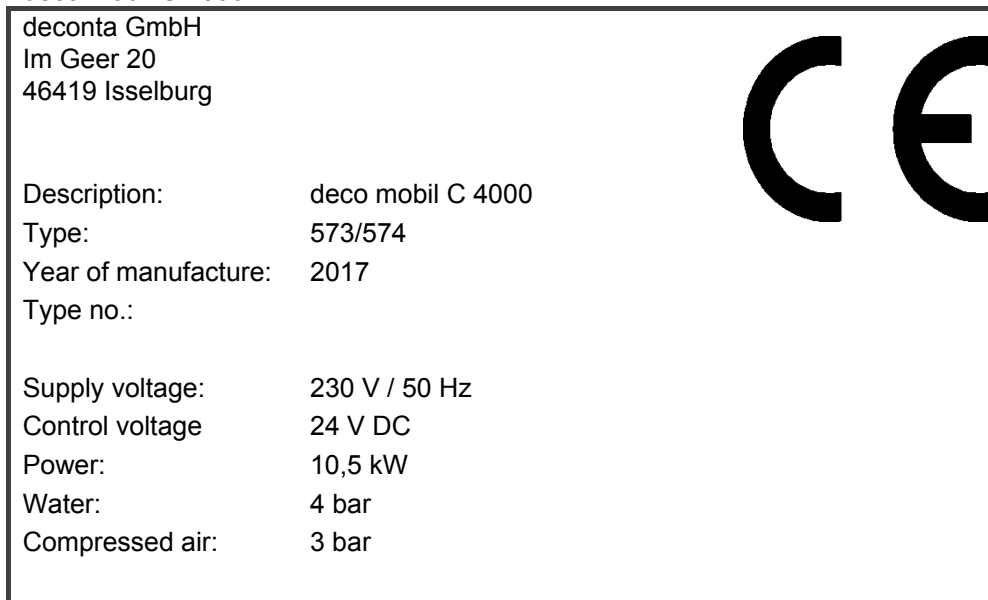


Fig. 1 137 Identification plate deco mobil C 4000

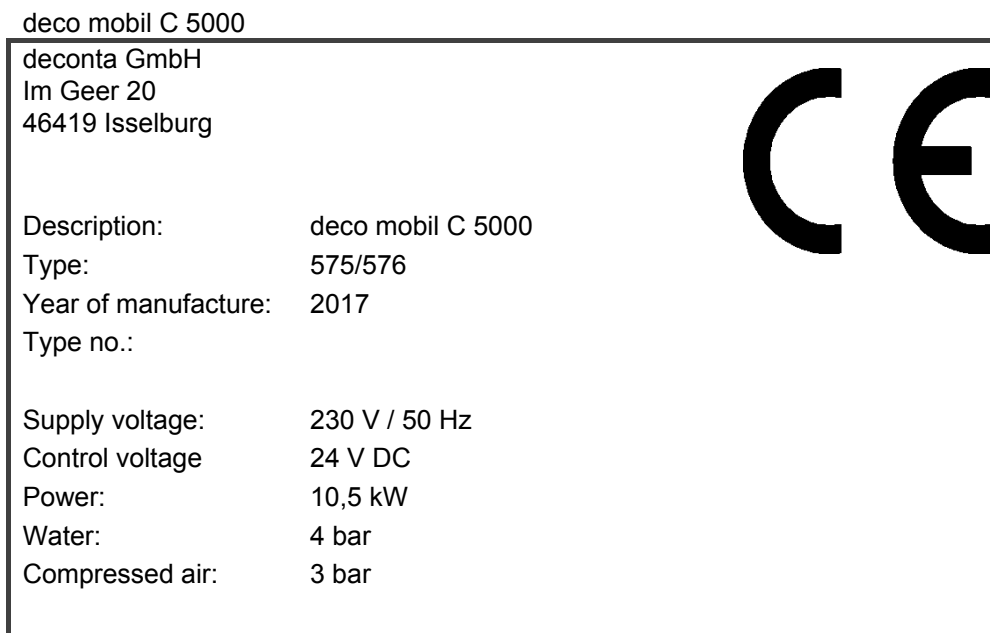


Fig. 1 138 Identification plate deco mobil C 5000

The identification plate states the minimum data of the machine. The minimum data has been supplemented by connection data.

**12.6 Declaration of conformity**

<b>EC declaration of conformity</b>		
<b>pursuant to the Machinery Directive 2006/42/EG Annex IIA</b>		
<p>We declare herewith that as a result of the manner in which the machine designated below was designed, the type of construction and the machines which, as a result have been brought on to the general market comply with the relevant fundamental regulations of the EU Rules for Safety and Health.</p>		
Description	deco mobil C	
Type no.:	<b>571, 572, 573, 574, 575, 576</b>	
Year of manufacture:	from 2014	
<p>complies with the following EC Directives:</p> <p><b>Machinery Directive 2006/42/EC</b></p> <p><b>Low Voltage Directive 2014/35/EU</b></p> <p><b>EMC - Directive 2014/30/EU</b></p>		
<p>Applied harmonized standards, particularly:</p> <p><b>EN ISO 13849-1:2016</b>      Safety of machinery – safety-related parts of control systems</p> <p><b>EN ISO 12100:2011</b>      Safety of machinery – General principles for design – Risk assessment and Risk reduction</p> <p><b>EN ISO 13857:2008</b>      Safety distances to prevent hazard zones being reached by upper and lower limbs</p> <p><b>EN ISO 14118:2018</b>      Safety of machinery – Prevention of unexpected start-up</p> <p><b>EN 60204-1:2019</b>      Safety of machinery – Electrical equipment of machinery</p>		
<p>This declaration will become invalid if any modification is made to this machinery. The special technical documents for this machine have been created according to Annex VII Part A.</p>		
Manufacturer/	deconta GmbH	
Authorised representative of documents	Im Geer 20 46419 Isselburg	
<u>Isselburg</u>	<u>12.02.2020</u>	<u>Christian Krolle</u>
Place	Date	Name - Managing Director-

## Images

Fig. 1 1	Dimensions of deco mobil C.....	12
Fig. 1 2	View of ECO 3000.....	25
Fig. 1 3	Structure of deco mobil C 4000.....	26
Fig. 1 4	Structure of deco mobil C 5000.....	27
Fig. 1 5	Options of deco mobil C ECO 3000.....	28
Fig. 1 6	Options of deco mobil C 4000.....	28
Fig. 1 7	Options of deco mobil C 5000.....	29
Fig. 1 8	Position of the supply connections.....	30
Fig. 1 9	Position of the socket and water supply in the contaminated area.....	31
Fig. 1 10	Depressurised connection.....	32
Fig. 1 11	Push-button for activating the shower (red circle).....	33
Fig. 1 12	Push-button for activating the vacuum cleaner (red circle).....	34
Fig. 1 13	Ball cock in the shower chamber.....	35
Fig. 1 14	Ball cock for emptying the tank in the technical room.....	36
Fig. 1 15	Discharge of fresh water tank.....	36
Fig. 1 16	Emergency shutdown switch.....	37
Fig. 1 17	Battery main switch.....	37
Fig. 1 18	Wheel hub and brake.....	41
Fig. 1 19	Overrun device.....	42
Fig. 1 20	Coupling head.....	42
Fig. 1 21	Sequence of tightening the wheel nuts.....	43
Fig. 1 22	Contact points for the jack.....	44
Fig. 1 23	Load specifications.....	45
Fig. 1 24	Snap-in indicator.....	46
Fig. 1 25	Plug of trailer.....	48
Fig. 1 26	Locking device.....	49
Fig. 1 27	Positioning the crank handle.....	49
Fig. 1 28	Extended support.....	50
Fig. 1 29	Release of the step.....	50
Fig. 1 30	Main screen.....	53
Fig. 1 31	Menu page 1.....	54
Fig. 1 32	Menu page 2.....	55
Fig. 1 33	Activation / deactivation of LED light.....	56
Fig. 1 34	Activation / deactivation of the optional negative pressure unit.....	56
Fig. 1 35	Activation / deactivation of the shower water pump(s).....	56
Fig. 1 36	Activation / deactivation of the STEP BY STEP water heating.....	56
Fig. 1 37	Activation / deactivation of the depressurised tank filling via container.....	56
Fig. 1 38	Resetting the pump.....	57
Fig. 1 39	Activation / deactivation of the water heating.....	57
Fig. 1 40	Activation / deactivation of the room heating.....	57
Fig. 1 41	Activation / deactivation of the sewage water system.....	57
Fig. 1 42	Activation / deactivation of the frost protection program.....	57
Fig. 1 43	Activation / deactivation of the optional cold water function.....	58

## Attachments

---

Fig. 1 44	Menu page 3.....	58
Fig. 1 45	Activation / deactivation continuous operation negative pressure unit.....	59
Fig. 1 46	Setting of the time for which the negative pressure unit continues to run after all persons have left the decon unit.....	59
Fig. 1 47	Enter key.....	59
Fig. 1 48	Activation / deactivation follow-up time light.....	59
Fig. 1 49	Enter key.....	60
Fig. 1 50	Setting of the shower water temperature .....	60
Fig. 1 51	Enter key.....	60
Fig. 1 52	Activation / deactivation sterilisation program .....	61
Fig. 1 53	Deactivation of sterilisation program .....	61
Fig. 1 54	Activation of sterilisation program .....	61
Fig. 1 55	Enter key.....	62
Fig. 1 56	Menu page 4.....	63
Fig. 1 57	Activation / deactivation of the weekly timer.....	63
Fig. 1 58	Enter key.....	64
Fig. 1 59	Menu page 5.....	65
Fig. 1 60	Activation / deactivation of SMS notification.....	66
Fig. 1 61	Activation / deactivation of SMS notification.....	66
Fig. 1 62	Activation / deactivation of SMS notification.....	66
Fig. 1 63	Activation / deactivation of SMS notification.....	66
Fig. 1 64	Activation / deactivation of SMS notification HEPA filter.....	66
Fig. 1 65	Selection of days and time .....	66
Fig. 1 66	Activation / deactivation of alarm system .....	68
Fig. 1 67	Status of the alarm system.....	68
Fig. 1 68	Main screen .....	69
Fig. 1 69	Menu page 1.....	70
Fig. 1 70	Menu page 2.....	71
Fig. 1 71	Activation / deactivation of LED light .....	72
Fig. 1 72	Activation / deactivation of the optional negative pressure unit .....	72
Fig. 1 73	Activation / deactivation of the shower water pump(s).....	72
Fig. 1 74	Activation / deactivation of the water heating .....	72
Fig. 1 75	Activation / deactivation of the STEP BY STEP water heating .....	72
Fig. 1 76	Activation / deactivation of the sewage water system.....	73
Fig. 1 77	Activation / deactivation of the frost protection program .....	73
Fig. 1 78	Activation / deactivation of the optional cold water function.....	73
Fig. 1 79	Menu page 3.....	74
Fig. 1 80	Activation / deactivation continuous operation negative pressure unit.....	75
Fig. 1 81	Follow-up time .....	75
Fig. 1 82	Entry menu .....	75
Fig. 1 83	Activation / deactivation follow-up time light.....	76
Fig. 1 84	Entry menu .....	76
Fig. 1 85	Setting of the shower water temperature .....	77
Fig. 1 86	Entry menu .....	77
Fig. 1 87	Activation / deactivation sterilisation program .....	77
Fig. 1 88	Deactivation of sterilisation program .....	78

## Attachments

---

Fig. 1 89	Activation of sterilisation program .....	78
Fig. 1 90	Enter key.....	78
Fig. 1 91	Menu page 4.....	79
Fig. 1 92	Activation / deactivation of the weekly timer.....	80
Fig. 1 93	Entry menu .....	80
Fig. 1 94	Menu page 5.....	81
Fig. 1 95	Activation / deactivation of SMS notification.....	81
Fig. 1 96	Activation / deactivation of SMS notification HEPA filter.....	82
Fig. 1 97	Selection of days and time .....	82
Fig. 1 98	Entry menu .....	82
Fig. 1 99	Activation / deactivation of alarm system .....	83
Fig. 1 100	Alarm system display activated.....	83
Fig. 1 101	Outer view of the communication module.....	84
Fig. 1 102	Inner view of communication module .....	85
Fig. 1 103	Mobile app autarkic version .....	86
Fig. 1 104	Menu status request .....	87
Fig. 1 105	Menu Remote control.....	88
Fig. 1 106	Menu GPS - tracking.....	89
Fig. 1 107	Google Maps map view .....	90
Fig. 1 108	Menu User management .....	91
Fig. 1 109	Sub-menu - Create users.....	92
Fig. 1 110	Warning message Filling level of cold water tank below 20% .....	93
Fig. 1 111	Warning message alarm system has been triggered .....	93
Fig. 1 112	Mobile app electric version .....	94
Fig. 1 113	Menu status request .....	95
Fig. 1 114	Menu Remote control.....	96
Fig. 1 115	Menu GPS - tracking.....	97
Fig. 1 117	Google Maps map view .....	98
Fig. 1 118	Menu User management .....	99
Fig. 1 119	Sub-menu - Create users.....	100
Fig. 1 120	Warning message Filling level of cold water tank below 20% .....	101
Fig. 1 121	Warning message alarm system has been triggered .....	101
Fig. 1 122	Connections of chambers 1-3 to the sewage water filtration system	103
Fig. 1 123	Connections of chambers 4-6 to the sewage water filtration system	103
Fig. 1 124	Compressed air feed.....	104
Fig. 1 125	Compressed air supply .....	104
Fig. 1 126	Vacuum cleaner connection in additional chamber .....	105
Fig. 1 127	Additional chamber with vacuum cleaner .....	105
Fig. 1 128	Vacuum cleaner connection.....	106
Fig. 1 129	Vacuum cleaner hose .....	106
Fig. 1 130	Sewage filter .....	109
Fig. 1 131	Filter key.....	109
Fig. 1 132	Filling level indicator.....	110
Fig. 1 133	Filter cover .....	111
Fig. 1 134	Electrically closing filter cover.....	112
Fig. 1 135	Shower hose .....	113

**Attachments**

---

Fig. 1 136	Identification plate deco mobil C ECO 3000 .....	121
Fig. 1 137	Identification plate deco mobil C 4000 .....	121
Fig. 1 138	Identification plate deco mobil C 5000 .....	122