

## Operating instructions (original) green dec

G 50, G 100, G 200, G 300, G 400, G 500



**G 50**



**G 100**



**G 200**

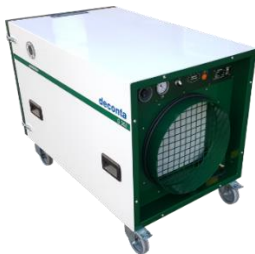

**G 300**



**G 400**



**G 500**

|                                                                                     |                                               |                                                                                               |              |
|-------------------------------------------------------------------------------------|-----------------------------------------------|-----------------------------------------------------------------------------------------------|--------------|
|  | deconta GmbH<br>Im Geer 20<br>46419 Isselburg | Phone: 02874/9156-0<br>Fax: 02874/9156-11<br>E-mail: info@deconta.com<br>Web: www.deconta.com | Language: EN |
|                                                                                     |                                               |                                                                                               | Version: 4   |
|                                                                                     |                                               |                                                                                               | Issue Date:  |
|                                                                                     |                                               |                                                                                               | 18.03.2024   |

|          |                                                        |           |
|----------|--------------------------------------------------------|-----------|
| <b>1</b> | <b>Product and manufacturer .....</b>                  | <b>6</b>  |
| 1.1      | Product.....                                           | 6         |
| 1.2      | Manufacturer .....                                     | 6         |
| 1.3      | Change index .....                                     | 6         |
| <b>2</b> | <b>About these operating instructions.....</b>         | <b>7</b>  |
| 2.1      | Purpose.....                                           | 7         |
| 2.2      | Availability .....                                     | 7         |
| 2.3      | Warnings.....                                          | 8         |
| 2.3.1    | Warning words and warning colours .....                | 8         |
| 2.3.2    | Structure .....                                        | 8         |
| 2.4      | Symbols .....                                          | 9         |
| 2.4.1    | Warning sign.....                                      | 9         |
| 2.4.2    | Instruction sign .....                                 | 9         |
| <b>3</b> | <b>Description of the machine .....</b>                | <b>10</b> |
| 3.1      | General description .....                              | 10        |
| 3.2      | Scope of delivery .....                                | 10        |
| 3.3      | Return delivery after termination of a lease .....     | 10        |
| 3.4      | Operating modes.....                                   | 11        |
| 3.4.1    | Available operating modes.....                         | 11        |
| 3.5      | Interfaces .....                                       | 11        |
| 3.6      | Type plate .....                                       | 12        |
| 3.6.1    | Content.....                                           | 12        |
| 3.6.2    | Version .....                                          | 12        |
| 3.6.3    | Position.....                                          | 12        |
| 3.7      | Accessories.....                                       | 12        |
| 3.7.1    | Negative pressure unit green dec G 50.....             | 12        |
| 3.7.2    | Negative pressure unit green dec G 100.....            | 14        |
| 3.7.3    | Negative pressure unit green dec G 200.....            | 15        |
| 3.7.4    | Negative pressure unit green dec G 300.....            | 16        |
| 3.7.5    | Negative pressure unit green dec G 400 and G 500 ..... | 18        |
| <b>4</b> | <b>Technical data.....</b>                             | <b>19</b> |
| 4.1      | Dimensions .....                                       | 19        |
| 4.2      | Weights .....                                          | 19        |
| 4.3      | Performance data.....                                  | 19        |
| 4.3.1    | Negative pressure unit green dec G 50.....             | 19        |
| 4.3.2    | Negative pressure unit green dec G 100.....            | 20        |
| 4.3.3    | Negative pressure unit green dec G 200.....            | 20        |
| 4.3.4    | Negative pressure unit green dec G 300.....            | 21        |
| 4.3.5    | Negative pressure unit green dec G 400.....            | 22        |
| 4.3.6    | Negative pressure unit green dec G 500.....            | 23        |
| 4.4      | Performance data special versions.....                 | 24        |
| 4.4.1    | Negative pressure unit green dec G 50.....             | 24        |
| 4.4.2    | Negative pressure unit green dec G 100.....            | 24        |

|          |                                                        |           |
|----------|--------------------------------------------------------|-----------|
| 4.4.3    | Negative pressure unit green dec G 200.....            | 24        |
| 4.4.4    | Negative pressure unit green dec G 300.....            | 25        |
| 4.4.5    | Negative pressure unit green dec G 400.....            | 25        |
| 4.4.6    | Negative pressure unit green dec G 500.....            | 25        |
| 4.5      | Environmental conditions .....                         | 25        |
| 4.6      | Noise emission .....                                   | 26        |
| 4.7      | Filter description / classification .....              | 27        |
| <b>5</b> | <b>Security .....</b>                                  | <b>29</b> |
| 5.1      | Intended use .....                                     | 29        |
| 5.2      | Misapplication .....                                   | 30        |
| 5.3      | Tasks and qualifications of the staff.....             | 31        |
| 5.4      | Notes on occupational health and safety .....          | 32        |
| <b>6</b> | <b>Transport.....</b>                                  | <b>33</b> |
| 6.1      | Loss of warranty claims .....                          | 33        |
| 6.2      | Off-site transport.....                                | 33        |
| 6.2.1    | Transport space.....                                   | 33        |
| 6.2.2    | Legislation .....                                      | 33        |
| 6.2.3    | Qualification of the staff .....                       | 33        |
| 6.2.4    | Warning of residual risks.....                         | 33        |
| 6.2.5    | Means of transportation .....                          | 34        |
| 6.3      | Internal transport .....                               | 34        |
| 6.3.1    | Transport space.....                                   | 34        |
| 6.3.2    | Legislation .....                                      | 34        |
| 6.3.3    | Warning of residual risks.....                         | 34        |
| 6.3.4    | Means of transportation .....                          | 34        |
| <b>7</b> | <b>Assembly.....</b>                                   | <b>35</b> |
| <b>8</b> | <b>Operation.....</b>                                  | <b>36</b> |
| 8.1      | Qualification of the staff .....                       | 36        |
| 8.2      | Warning of residual risks .....                        | 36        |
| 8.3      | Personal protective equipment required .....           | 36        |
| 8.4      | Number of persons.....                                 | 36        |
| 8.5      | Tools needed .....                                     | 36        |
| 8.6      | Required equipment .....                               | 36        |
| 8.7      | Negative pressure unit with control SE .....           | 37        |
| 8.7.1    | Room negative pressure maintenance.....                | 37        |
| 8.8      | Negative pressure units with SRE connect control ..... | 38        |
| 8.8.1    | Create user account .....                              | 39        |
| 8.8.2    | Add the machine to the user account.....               | 40        |
| 8.8.3    | Preparation .....                                      | 43        |
| 8.8.4    | Manual operation.....                                  | 43        |
| 8.8.5    | Automatic operation.....                               | 44        |
| 8.8.6    | Day / Night Settings (Day / Night) .....               | 45        |
| 8.8.7    | Standby mode .....                                     | 45        |

|           |                                                                            |           |
|-----------|----------------------------------------------------------------------------|-----------|
| 8.8.8     | Consumption .....                                                          | 46        |
| 8.8.9     | Dust Sensor .....                                                          | 46        |
| 8.8.10    | Service .....                                                              | 47        |
| 8.8.11    | Device information .....                                                   | 49        |
| 8.8.12    | Alarms .....                                                               | 50        |
| 8.8.13    | Switch off the unit .....                                                  | 52        |
| <b>9</b>  | <b>Maintenance .....</b>                                                   | <b>53</b> |
| 9.1       | Loss of warranty claims .....                                              | 53        |
| 9.2       | Maintenance .....                                                          | 53        |
| 9.3       | Warning of residual risks .....                                            | 53        |
| 9.3.1     | Personal protective equipment required .....                               | 54        |
| 9.4       | Filter change information .....                                            | 54        |
| 9.4.1     | Control SE .....                                                           | 54        |
| 9.4.2     | Control SRE connect .....                                                  | 55        |
| 9.5       | Filter change .....                                                        | 55        |
| 9.5.1     | Procedure using the G 300 as an example .....                              | 56        |
| 9.6       | Troubleshooting and fault clearance .....                                  | 59        |
| 9.6.1     | Possible malfunctions and tips for rectifying malfunctions .....           | 59        |
| <b>10</b> | <b>Spare parts .....</b>                                                   | <b>60</b> |
| 10.1      | Negative pressure unit green dec G 50 .....                                | 60        |
| 10.2      | Negative pressure unit green dec G 100 .....                               | 61        |
| 10.3      | Negative pressure unit green dec G 200 .....                               | 62        |
| 10.4      | Negative pressure unit green dec G 300 .....                               | 63        |
| 10.5      | Negative pressure unit green dec G 400 .....                               | 64        |
| 10.6      | Negative pressure unit green dec G 500 .....                               | 65        |
| <b>11</b> | <b>Circuit diagrams .....</b>                                              | <b>66</b> |
| 11.1      | Negative pressure unit green dec G 50 SE, 110 volt version .....           | 66        |
| 11.2      | Negative pressure unit green dec G 50 SE, 230 volt version .....           | 67        |
| 11.3      | Negative pressure unit green dec G 100 SE, 110 volt version .....          | 68        |
| 11.4      | Negative pressure unit green dec G 100 SE, 230 volt version .....          | 69        |
| 11.5      | Negative pressure unit green dec G 100 SRE connect, 230 volt version ..... | 70        |
| 11.6      | Negative pressure unit green dec G 200 SE, 110 volt version .....          | 71        |
| 11.7      | Negative pressure unit green dec G 200 SE, 230 volt version .....          | 72        |
| 11.8      | Negative pressure unit green dec G 200 SRE connect, 230 volt version ..... | 73        |
| 11.9      | Negative pressure unit green dec G 300 SE, 110 volt version .....          | 74        |
| 11.10     | Negative pressure unit green dec G 300 SE, 230 volt version .....          | 75        |
| 11.11     | Negative pressure unit green dec G 300 SRE connect, 230 volt version ..... | 76        |
| 11.12     | Negative pressure unit green dec G 400 SE, 230 volt version .....          | 77        |
| 11.13     | Negative pressure unit green dec G 400 SRE connect, 230 volt version ..... | 78        |
| 11.14     | Negative pressure unit green dec G 500 SE, 230 volt version .....          | 79        |
| 11.15     | Negative pressure unit green dec G 500 SRE connect, 230 volt version ..... | 80        |
| <b>12</b> | <b>Storage .....</b>                                                       | <b>81</b> |
| 12.1      | Environmental conditions .....                                             | 81        |

- 12.2 Requirements.....81
- 13 Disposal .....82**
  - 13.1 Qualification of the staff .....82
  - 13.2 Legislation.....82
  - 13.3 Waste.....82
- 14 EC Declaration of Conformity .....83**

# 1 Product and manufacturer

## 1.1 Product

This operating manual describes the following product:

Negative pressure unit green dec.

Types: G 50, G 100, G 200, G 300, G 400, G 500

## 1.2 Manufacturer

|                  |                                                                                   |
|------------------|-----------------------------------------------------------------------------------|
| Name and address | deconta GmbH<br>Im Geer 20<br>46419 Isselburg                                     |
|                  |  |
| Phone            | 02874/9156-0                                                                      |
| Fax              | 02874/9156-11                                                                     |
| E-mail           | info@deconta.com                                                                  |
| Internet         | www.deconta.com                                                                   |

## 1.3 Change index

| Date       | Version | Change            | Responsible   |
|------------|---------|-------------------|---------------|
| 07.03.2023 | 4       | complete revision | Thomas Boland |

## 2 About these operating instructions

For proper and safe use of the machine, follow the descriptions and recommended actions in these operating instructions.

Keep this manual for future reference until the machine has been disposed of.

### 2.1 Purpose

These operating instructions contain information on the safe, trouble-free and economical use of the machine.

This information is intended for persons who perform tasks with or in connection with the machine.

The following table gives an overview of persons and tasks.

| Person                         | Task                                                                                                                                                |
|--------------------------------|-----------------------------------------------------------------------------------------------------------------------------------------------------|
| Operator                       | << Machine-specific >>                                                                                                                              |
| Occupational safety specialist | <ul style="list-style-type: none"> <li>• Carry out a risk assessment</li> <li>• Create operating instructions</li> <li>• Instruct people</li> </ul> |
| Maintenance staff              | Maintenance of the mechanics                                                                                                                        |
| Electrician (EFK)              | Installation and maintenance of electrical equipment                                                                                                |
| Freight forwarder              | Off-site transport of the machine                                                                                                                   |
| Conveyor                       | Internal transport of the machine                                                                                                                   |
| Disposer                       | Dispose of the machine in a legally compliant, proper and professional manner.                                                                      |

### 2.2 Availability

The operator shall make these operating instructions or extracts thereof available to persons who perform tasks with or in connection with the machine.

The operator keeps these operating instructions or extracts thereof within easy reach in the immediate vicinity of the machine.

When handing over the machine to another person, the operator passes these operating instructions on to that person.





## 2.3 Warnings

These operating instructions contain warnings of residual dangers.

The classification of the warnings is based on the severity of the damage that can occur if the warnings are disregarded and recommended actions are not followed.

### 2.3.1 Warning words and warning colours

Warnings are introduced with one of the following warning words and marked with a corresponding warning colour.

| Warning word  | Meaning                                                                              | Warning colour                                                                        |
|---------------|--------------------------------------------------------------------------------------|---------------------------------------------------------------------------------------|
| DANGER        | Consequence for non-compliance:<br>Death or most serious injuries.                   |    |
| WARNING       | Consequence for non-compliance:<br>Death or most severe injuries possible.           |    |
| CAUTION       | Consequence for non-compliance:<br>Severe or minor injuries possible.                |    |
| NOTE          | Consequence for non-compliance:<br>Property damage or environmental damage possible. |  |
| SAFE ACTIVITY | Implement the following action guide.                                                | -                                                                                     |

### 2.3.2 Structure

Warnings are structured according to the SAFE method:

|          |                                                                                                                                      |
|----------|--------------------------------------------------------------------------------------------------------------------------------------|
| <b>S</b> | Warning word (DANGER; WARNING, CAUTION or NOTE)                                                                                      |
| <b>A</b> | Nature and source of the hazard<br>Description of the hazard and the cause of the hazard                                             |
| <b>F</b> | Follow<br>Description of the possible consequences for humans, animals and the environment that may occur as a result of the hazard. |
| <b>E</b> | Escape<br>Recommendations for action on how to avoid hazards                                                                         |





## 2.4 Symbols

The following symbols are used in these operating instructions.

### 2.4.1 Warning sign

The warning sign is a safety sign that warns of a risk or danger.



The following table gives an overview of warning signs used and their meaning.

| Symbol                                                                            | Meaning                       | Symbol                                                                             | Meaning              |
|-----------------------------------------------------------------------------------|-------------------------------|------------------------------------------------------------------------------------|----------------------|
|  | Warning of electrical voltage |  | General warning sign |

### 2.4.2 Instruction sign

The instruction sign is a safety sign that prescribes a certain behaviour.

The following table gives an overview of the instruction signs used and their meaning.

| Symbol                                                                              | Meaning                | Symbol                                                                               | Meaning                 |
|-------------------------------------------------------------------------------------|------------------------|--------------------------------------------------------------------------------------|-------------------------|
|  | Use hearing protection |  | Use protective clothing |
|  | Wear safety shoes      |                                                                                      |                         |

### **3 Description of the machine**

This section contains information for understanding the machine.

#### **3.1 General description**

##### **General description of the product**

The machine (the negative pressure unit) was designed and built by the company deconta GmbH, Im Geer 20, 46419 Isselburg.

Negative pressure unit for filtering asbestos-contaminated room air via a 3-stage filter unit (G 50 only 2-stage). The built-in HEPA filter meets the requirements of EN 1822 class H 13 or H 14.

##### **Procedure for carrying out the risk assessment for machinery**

- Language of the risk assessment: German
- Risk assessment: EN ISO 12100 Safety of machinery - General principles for design - Risk assessment and risk reduction, three-step iterative process for risk reduction in conjunction with Machinery Directive 2006/42/EC, Annex I, first general principle.
- Risk assessment: DIN ISO/TR 14121-2 Safety of machinery - Risk assessment - Part 2: Practical guide and examples of procedures, 6.3 Risk graph; Determination of the required performance level (PLr): EN ISO 13849-1 Safety of machinery - Safety-related parts of control systems - Part 1: General principles for design; Determination of SIL (Safety Integrity Level): EN 62061 Safety of machinery - Functional safety of safety-related electrical, electronic and programmable electronic control systems.

#### **3.2 Scope of delivery**

The delivery scope of the machine includes the following items:

- Negative pressure unit green dec
- These operating instructions
- Transport cover
- Sealing plug

#### **3.3 Return delivery after termination of a lease**

For the protection of our customers and in terms of dangerous goods transport regulations, we must insist on the following return delivery conditions:

- As listed above
- Thoroughly cleaned (ready for use)
- Free from any adhesive residues
- Without residual fibre encapsulation
- Without filter
- Without damage

### **3.4 Operating modes**

#### **3.4.1 Available operating modes**

##### **Type of use**

The machine is intended exclusively for use in the following types of use.

Use for other types of use is not in accordance with the intended use.

##### **User groups**

- Commercial users

##### **User environment**

- outdoors
- on roofed areas
- in rooms closed on all sides

##### **Operating modes**

Operating modes for use:

- Automatic mode (SRE connect version only)
- Manual operation

### **3.5 Interfaces**

This section contains information about interfaces.

The following interfaces are available on the machine:

- Human product: Control panel, touch screen
- Product power supply: Electrical power supply 110 V / 230 V / 400 V
- Product waste: Connection spigot for clean air
- Product material feed: Connecting piece for contaminated air
- Product building: feet or castor wheels

### 3.6 Type plate

The type plate contains information for identifying the machine.

#### 3.6.1 Content

The following illustration shows an example type plate.



#### 3.6.2 Version

Aluminium plate, riveted

#### 3.6.3 Position

Near the control panel on the outlet side.

### 3.7 Accessories

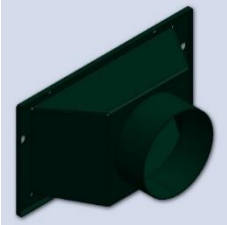
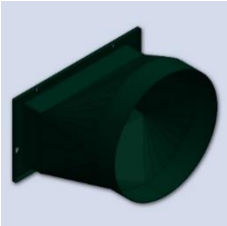
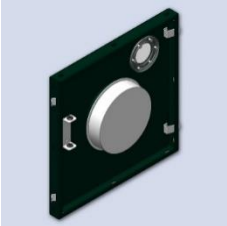

The following accessories are optionally available for the machine:

#### 3.7.1 Negative pressure unit green dec G 50

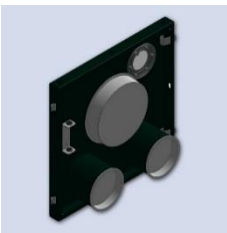
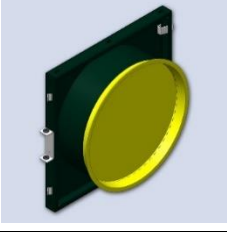
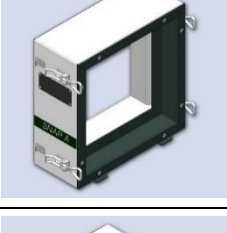
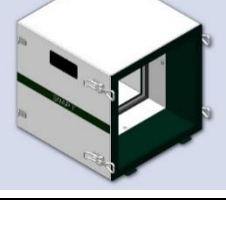
| Designation              | Item no. | Illustration                                                                          |
|--------------------------|----------|---------------------------------------------------------------------------------------|
| Air outlet flange NW 150 | BO13928  |  |
| Air outlet flange NW 300 | BO13931  |  |
| Inlet flange NW 150      | BO13949  |  |

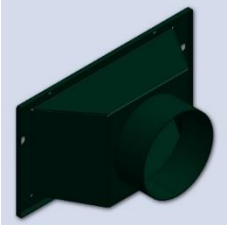
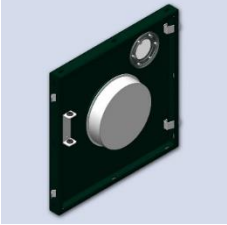
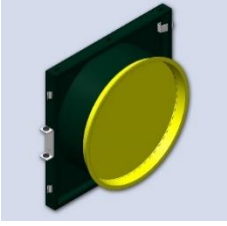

| Designation                                            | Item no. | Illustration                                                                          |
|--------------------------------------------------------|----------|---------------------------------------------------------------------------------------|
| Inlet flange 1x NW 150 and<br>2x NW 100                | BO20998  |    |
| Inlet flange NW 300                                    | BO15422  |    |
| Adapter 4-fold, 4 x NW 100,<br>Individually adjustable | BO14211  |   |
| Adhesive frame                                         | BO23144  |  |
| SNAP A double filtration                               | 687      |  |
| SNAP T pocket filter                                   | 682      |  |



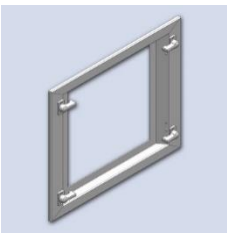
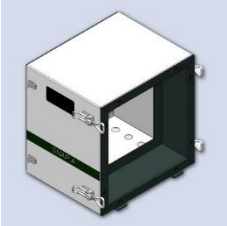
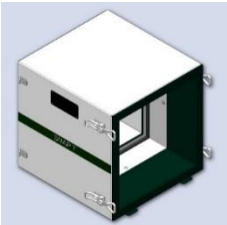

3.7.2 Negative pressure unit green dec G 100

| Designation                                         | Item no. | Figure                                                                                |
|-----------------------------------------------------|----------|---------------------------------------------------------------------------------------|
| Air outlet flange NW 150                            | BO13928  |    |
| Air outlet flange NW 300                            | BO13931  |    |
| Inlet flange NW 150                                 | BO13949  |   |
| Inlet flange 1x NW 150 and 2x NW 100                | BO20998  |  |
| Inlet flange NW 300                                 | BO15422  |  |
| Adapter 4-fold, 4 x NW 100, Individually adjustable | BO14211  |  |

| Designation              | Item no. | Figure                                                                               |
|--------------------------|----------|--------------------------------------------------------------------------------------|
| Adhesive frame           | BO23144  |   |
| SNAP A double filtration | 681      |   |
| SNAP T pocket filter     | 682      |  |

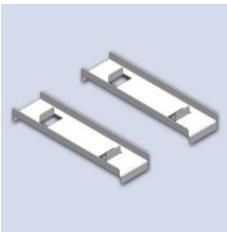
3.7.3 Negative pressure unit green dec G 200



| Designation             | Item no. | Figure                                                                                |
|-------------------------|----------|---------------------------------------------------------------------------------------|
| Inlet flange NW 300     | BO14010  |  |
| Inlet flange 2 x NW 300 | BO19660  |  |
| Inlet flange 3 x NW 150 | BO16629  |  |

| Designation              | Item no. | Figure                                                                                |
|--------------------------|----------|---------------------------------------------------------------------------------------|
| Stacking device set      | BO14701  |    |
| Adhesive frame           | BO23141  |    |
| SNAP A double filtration | 685      |   |
| SNAP T pocket filter     | 686      |  |
| Filter unit FG 200 SNAP  | 765      |  |

3.7.4 Negative pressure unit green dec G 300

| Designation         | Item no. | Figure                                                                                |
|---------------------|----------|---------------------------------------------------------------------------------------|
| Inlet flange NW 450 | BO14695  |  |

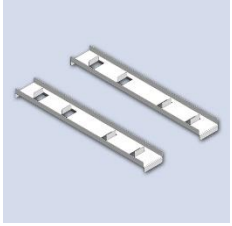

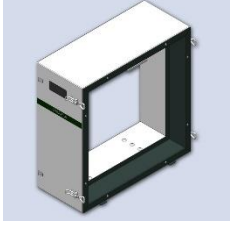
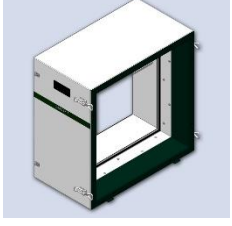
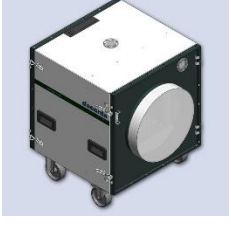
| Designation              | Item no. | Figure                                                                                |
|--------------------------|----------|---------------------------------------------------------------------------------------|
| Inlet flange 4x NW 150   | BO22214  |    |
| Stacking device set      | BO14702  |    |
| Adhesive frame           | BO23138  |   |
| SNAP A double filtration | 669      |  |
| SNAP T pocket filter     | 684      |  |
| Filter unit FG 300 SNAP  | 697      |  |

3.7.5 Negative pressure unit green dec G 400 and G 500

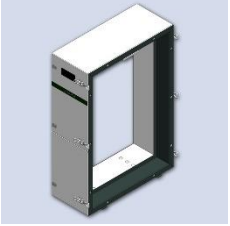
| Designation              | Item no. | Figure                                                                              |
|--------------------------|----------|-------------------------------------------------------------------------------------|
| Inlet flange NW 450      | BO20486  |  |
| SNAP A double filtration | 806      |  |

## 4 Technical data

### 4.1 Dimensions

|       | Length x width x height (mm) |
|-------|------------------------------|
| G 50  | 525 x 390 x 390              |
| G 100 | 770 x 410 x 410              |
| G 200 | 970 x 410 x 840              |
| G 300 | 1150 x 720 x 840             |
| G 400 | 1200 x 720 x 1150            |
| G 500 | Fan unit 1180 x 785 x 955    |
|       | Filter unit 715 x 720 x 1150 |

### 4.2 Weights

|       | Weight incl. filter (kg) |
|-------|--------------------------|
| G 50  | 18,8                     |
| G 100 | 27,5                     |
| G 200 | 55,0                     |
| G 300 | 79,0                     |
| G 400 | 105,0                    |
| G 500 | Fan unit 110 .0          |
|       | Filter unit 63 .0        |

### 4.3 Performance data

*All data on air performance and volumetric flows taking into account a measurement tolerance of  $\pm 15\%$  referred to the measuring range end value, determined in a multi-point measurement procedure with a calibrated impeller anemometer.*

#### 4.3.1 Negative pressure unit green dec G 50

|                                                          | 110 V                  | 230 V                  |
|----------------------------------------------------------|------------------------|------------------------|
| Air output free-blowing max.                             | 1500 m <sup>3</sup> /h | 1500 m <sup>3</sup> /h |
| Air performance with deconta H13 filter, max.            | 1100 m <sup>3</sup> /h | 1100 m <sup>3</sup> /h |
| Air performance with deconta H13 filter, prefilter, max. | 1000 m <sup>3</sup> /h | 1000 m <sup>3</sup> /h |
| Power connection                                         | 100 - 120 V            | 230 V                  |
| Power consumption                                        | 3 A                    | 1,2 A                  |
| Engine power                                             | 0.17 kW                | 0.17 kW                |

|                  | <b>110 V</b>                   | <b>230 V</b> |
|------------------|--------------------------------|--------------|
| Power cable type | H07RN-F 3G1.5                  |              |
| Protection class | I                              |              |
| Protection class | IP 54                          |              |
| Filter system    | 2-stage                        |              |
| Pre-filter       | EU 4                           |              |
| HEPA filter      | according to EN 1822 class H13 |              |

#### 4.3.2 Negative pressure unit green dec G 100

|                                                                             | <b>110 V</b>                   | <b>230 V</b>           |
|-----------------------------------------------------------------------------|--------------------------------|------------------------|
| Air output free-blowing max.                                                | 2000 m <sup>3</sup> /h         | 2300 m <sup>3</sup> /h |
| Air performance with deconta H13 filter, max.                               | 1500 m <sup>3</sup> /h         | 1800 m <sup>3</sup> /h |
| Air performance with deconta H13 filter, pre- and intermediate filter, max. | 1350 m <sup>3</sup> /h         | 1650 m <sup>3</sup> /h |
| Power connection                                                            | 100 - 120 V                    | 230 V                  |
| Power consumption                                                           | 4 A                            | 2,5 A                  |
| Engine power                                                                | 0.345 kW                       | 0.5 kW                 |
| Power cable type                                                            | H07RN-F 3G1.5                  |                        |
| Protection class                                                            | I                              |                        |
| Protection class                                                            | IP 54                          |                        |
| Filter system                                                               | 3-stage                        |                        |
| Pre-filter                                                                  | EU 3                           |                        |
| Intermediate filter                                                         | EU 4                           |                        |
| HEPA filter                                                                 | according to EN 1822 class H13 |                        |

#### 4.3.3 Negative pressure unit green dec G 200

|                                                                             | <b>110 V</b>           | <b>230 V</b>           |
|-----------------------------------------------------------------------------|------------------------|------------------------|
| Air output free-blowing max.                                                | 4000 m <sup>3</sup> /h | 4500 m <sup>3</sup> /h |
| Air performance with deconta H13 filter, max.                               | 3050 m <sup>3</sup> /h | 3400 m <sup>3</sup> /h |
| Air performance with deconta H13 filter, pre- and intermediate filter, max. | 2500 m <sup>3</sup> /h | 3000 m <sup>3</sup> /h |
| Power connection                                                            | 100 - 120 V            | 230 V                  |
| Power consumption                                                           | 7 A                    | 4 A                    |
| Engine power                                                                | 2x 0.345 kW            | 0.75 kW                |

|                     | <b>110 V</b>                   | <b>230 V</b> |
|---------------------|--------------------------------|--------------|
| Power cable type    | H07RN-F 3G1.5                  |              |
| Protection class    | I                              |              |
| Protection class    | IP 54                          |              |
| Filter system       | 3-stage                        |              |
| Pre-filter          | EU 3                           |              |
| Intermediate filter | EU 4                           |              |
| HEPA filter         | according to EN 1822 class H13 |              |

#### 4.3.4 Negative pressure unit green dec G 300

|                                                                             | <b>110 V</b>                   | <b>230 V</b>           |
|-----------------------------------------------------------------------------|--------------------------------|------------------------|
| Air output free-blowing max.                                                | 7400 m <sup>3</sup> /h         | 8000 m <sup>3</sup> /h |
| Air performance with deconta H13 filter, max.                               | 5150 m <sup>3</sup> /h         | 5700 m <sup>3</sup> /h |
| Air performance with deconta H13 filter, pre- and intermediate filter, max. | 4000 m <sup>3</sup> /h         | 5150 m <sup>3</sup> /h |
| Power connection                                                            | 100 - 120 V                    | 230 V                  |
| Power consumption                                                           | 15 A                           | 8 A                    |
| Engine power                                                                | 4x 0.345 kW                    | 1.5 kW                 |
| Power cable type                                                            | H07RN-F 3G2,5                  | H07RN-F 3G1.5          |
| Protection class                                                            | I                              |                        |
| Protection class                                                            | IP 54                          |                        |
| Filter system                                                               | 3-stage                        |                        |
| Pre-filter                                                                  | EU 3                           |                        |
| Intermediate filter                                                         | EU 4                           |                        |
| HEPA filter                                                                 | according to EN 1822 class H13 |                        |

4.3.5 Negative pressure unit green dec G 400

When using a residual current protective device, only all-current sensitive residual current protective devices (type B or B+) are permitted.

**HINWEIS**

When the power supply to the unit is switched on, pulsed charging currents of the capacitors in the integrated EMC filter can cause RCD protection devices to respond with instantaneous tripping.

We recommend residual current circuit breakers with a delayed tripping (super-resistant).

|                                                                             |                                |
|-----------------------------------------------------------------------------|--------------------------------|
| Air output free-blowing max.                                                | 9500 m <sup>3</sup> /h         |
| Air performance with deconta H13 filter, max.                               | 8400 m <sup>3</sup> /h         |
| Air performance with deconta H13 filter, pre- and intermediate filter, max. | 7800 m <sup>3</sup> /h         |
| Power connection                                                            | 400 V                          |
| Power consumption                                                           | 5 A                            |
| Engine power                                                                | 1.5 kW                         |
| Power cable type                                                            | 16A CEE surface-mounted plug   |
| Protection class                                                            | I                              |
| Protection class                                                            | IP 54                          |
| Filter system                                                               | 3-stage                        |
| Pre-filter                                                                  | EU 3                           |
| Intermediate filter                                                         | EU 4                           |
| HEPA filter                                                                 | according to EN 1822 class H13 |

4.3.6 Negative pressure unit green dec G 500

When using a residual current protective device, only all-current sensitive residual current protective devices (type B or B+) are permitted.

**HINWEIS**

When the power supply to the unit is switched on, pulsed charging currents of the capacitors in the integrated EMC filter can cause RCD protection devices to respond with instantaneous tripping.

We recommend residual current circuit breakers with a delayed tripping (super-resistant).

|                                                                             |                                |
|-----------------------------------------------------------------------------|--------------------------------|
| Air output free-blowing max.                                                | 15000 m <sup>3</sup> /h        |
| Air performance with deconta H13 filter, max.                               | 13000 m <sup>3</sup> /h        |
| Air performance with deconta H13 filter, pre- and intermediate filter, max. | 12000 m <sup>3</sup> /h        |
| Power connection                                                            | 400 V                          |
| Power consumption                                                           | 5 A                            |
| Engine power                                                                | 5.7 kW                         |
| Power cable type                                                            | 16A CEE surface-mounted plug   |
| Protection class                                                            | I                              |
| Protection class                                                            | IP 54                          |
| Filter system                                                               | 3-stage                        |
| Pre-filter                                                                  | EU 3                           |
| Intermediate filter                                                         | EU 4                           |
| HEPA filter                                                                 | according to EN 1822 class H13 |

#### 4.4 Performance data special versions

The units of the green dec series can be equipped with double filtration (2x HEPA filters in series), either by an optional add-on housing "SNAP" or by an extended housing version.

When using double filtration, the maximum volume flow and the unit dimensions change.

The modified technical data can be found in the following tables.

##### 4.4.1 Negative pressure unit green dec G 50

|                                                                              |        |
|------------------------------------------------------------------------------|--------|
| Air performance with deconta H13 filter (double filtration), max.            |        |
| Air performance with deconta H13 filter (double filtration), prefilter, max. |        |
| Length with add-on housing "SNAP"                                            | 680 mm |

##### 4.4.2 Negative pressure unit green dec G 100

|                                                                                                       |                        |
|-------------------------------------------------------------------------------------------------------|------------------------|
| Air performance with deconta H13 filter (double filtration), max.                                     | 1700 m <sup>3</sup> /h |
| Air performance with deconta H13 filter (double filtration), pre-filter and intermediate filter, max. | 1370 m <sup>3</sup> /h |
| Length with add-on housing "SNAP"                                                                     | 1070 mm                |

##### 4.4.3 Negative pressure unit green dec G 200

|                                                                                                       |                        |
|-------------------------------------------------------------------------------------------------------|------------------------|
| Air performance with deconta H13 filter (double filtration), max.                                     | 3200 m <sup>3</sup> /h |
| Air performance with deconta H13 filter (double filtration), pre-filter and intermediate filter, max. | 2800 m <sup>3</sup> /h |
| Length with add-on housing "SNAP"                                                                     | 1450 mm                |
| Length with extended housing version                                                                  | 1440 mm                |



4.4.4 Negative pressure unit green dec G 300

|                                                                                                 |                        |
|-------------------------------------------------------------------------------------------------|------------------------|
| Air performance with deconta H13 filter (double filtration), max.                               | 5300 m <sup>3</sup> /h |
| Air performance with deconta H13 filter (double filtration), pre- and intermediate filter, max. | 4750 m <sup>3</sup> /h |
| Length with add-on housing "SNAP                                                                | 1270 mm                |
| Length with extended housing version                                                            | 1260 mm                |

4.4.5 Negative pressure unit green dec G 400

|                                                                                                       |         |
|-------------------------------------------------------------------------------------------------------|---------|
| Air performance with deconta H13 filter (double filtration), max.                                     |         |
| Air performance with deconta H13 filter (double filtration), pre-filter and intermediate filter, max. |         |
| Length with add-on housing "SNAP                                                                      | 1500 mm |
| Length with extended housing version                                                                  |         |

4.4.6 Negative pressure unit green dec G 500

|                                                                                                 |         |
|-------------------------------------------------------------------------------------------------|---------|
| Air performance with deconta H13 filter (double filtration), max.                               |         |
| Air performance with deconta H13 filter (double filtration), pre- and intermediate filter, max. |         |
| Length filter unit with add-on housing "SNAP                                                    | 1015 mm |

**4.5 Environmental conditions**

|                     |                     |
|---------------------|---------------------|
| Ambient temperature | 0 °C to +45 °C      |
| Relative humidity   | 70 % non-condensing |

**4.6 Noise emission**

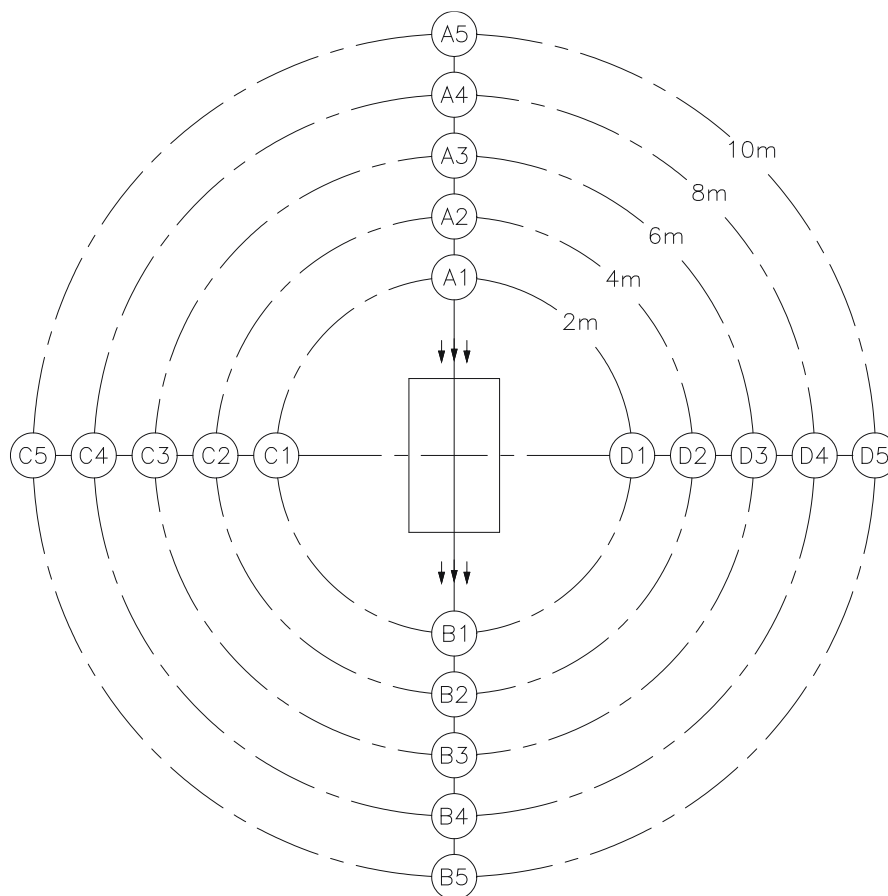

**Status:**

Engine power 100%, outdoor area, values in dB (A)

| Device | A1 | A2 | A3 | A4 | A5 | B1 | B2 | B3 | B4 | B5 | C1<br>D1 | C2<br>D2 | C3<br>D3 | C4<br>D4 | C5<br>D5 |
|--------|----|----|----|----|----|----|----|----|----|----|----------|----------|----------|----------|----------|
| G 50   | 62 | 59 | 57 | 55 | 53 | 67 | 62 | 59 | 56 | 54 | 64       | 60       | 58       | 55       | 51       |
| G 100  | 69 | 65 | 61 | 59 | 56 | 71 | 67 | 63 | 60 | 58 | 65       | 60       | 58       | 56       | 55       |
| G 200  | 75 | 73 | 67 | 64 | 63 | 75 | 69 | 64 | 61 | 60 | 68       | 65       | 63       | 62       | 59       |
| G 300  | 80 | 75 | 73 | 69 | 67 | 80 | 73 | 69 | 69 | 67 | 71       | 68       | 65       | 63       | 62       |
| G 400  | 83 | 81 | 77 | 76 | 75 | 86 | 83 | 76 | 75 | 74 | 79       | 78       | 75       | 74       | 72       |
| G 500  | 93 | 89 | 86 | 84 | 82 | 97 | 94 | 91 | 87 | 84 | 91       | 89       | 88       | 85       | 83       |



Wear hearing protection in the immediate vicinity of the G 400 and G 500 negative pressure units.

By attaching a silencer, the sound level can be reduced, taking into account power losses.

#### 4.7 Filter description / classification

A 3-stage filter combination is integrated in the unit (G 50 only 2-stage)

**In detail:**

| <b>Pre- and intermediate filters</b>    | <b>Pre-filter</b>                    | <b>Intermediate filter</b>           |
|-----------------------------------------|--------------------------------------|--------------------------------------|
| Grade according to DIN 24185 / EN 779   | G3 / EU3                             | G4 / EU4                             |
| Frame                                   | Cardboard frame,<br>47 mm wide       | Cardboard frame,<br>47 mm wide       |
| Filter medium                           | Glass fibre                          | Synthetic                            |
| Separation efficiency (Am)              | 85 %                                 | 90 %                                 |
| Nominal volume flow:                    | 5400m <sup>3</sup> /h/m <sup>2</sup> | 5400m <sup>3</sup> /h/m <sup>2</sup> |
| Nominal face velocity at nominal volume | 1.5 m/s                              | 1.5 m/s                              |
| Initial pressure difference             | 30 Pa                                | 42 Pa                                |
| Recommended final pressure difference   | 450 Pa                               | 250 Pa                               |
| Temperature / Humidity                  | 100°C/100% RF<br>(relative humidity) | 100°C/100% RF<br>(relative humidity) |
| Filter dimensions (in mm):              |                                      |                                      |
| G 50                                    | ---                                  | 305 x 305 x 47                       |
| G100                                    | 305 x 305 x 47                       | 305 x 305 x 47                       |
| G200                                    | 305 x 610 x 47                       | 305 x 610 x 47                       |
| G300                                    | 610 x 610 x 47                       | 610 x 610 x 47                       |
| G400                                    | 610 x 910 x 47                       | 610 x 910 x 47                       |
| G500                                    | 610 x 910 x 47                       | 610 x 910 x 47                       |

**HEPA filter**

|                                                                                 |                                                                                                                |
|---------------------------------------------------------------------------------|----------------------------------------------------------------------------------------------------------------|
| Frame                                                                           | Plastic or aluminium                                                                                           |
| Filter medium                                                                   | Micro glass fibre paper                                                                                        |
| Casting compound                                                                | Polyurethane                                                                                                   |
| Seal                                                                            | Polyurethane                                                                                                   |
| Filter class                                                                    | H13 or H 14 according to EN 1822                                                                               |
| Temperature / Humidity                                                          | 70°C/100% RF<br>(relative humidity)                                                                            |
| Filter dimensions (in mm):<br>G 50<br>G 100<br>G 200<br>G 300<br>G 400<br>G 500 | 284 x 284 x 150<br>305 x 305 x 292<br>305 x 610 x 292<br>610 x 610 x 292<br>610 x 910 x 292<br>610 x 910 x 292 |
| Handle protection                                                               | on both sides                                                                                                  |

## 5 Security

This section contains information on the protection of humans, domestic and farm animals and the environment.

### 5.1 Intended use

The machine is intended exclusively for the following use:

#### **Intended use**

The negative pressure unit is used to filter non-condensing room air contaminated with asbestos fibres, in the temperature range up to +45 °C, with exhaust air discharge to the outside.

During asbestos removal work inside closed rooms, it is important to exclude the possibility of asbestos fibres leaving the removal area and thus posing a danger to people and the environment. For these reasons, remediation areas (also called black areas) are separated from the asbestos-free areas and kept in dynamic negative pressure by means of negative pressure maintenance devices.

An integrated filter system creates the precondition that the asbestos fibre concentration in the exhaust air is not exceeded. The exhaust air is discharged into the open air.

The unit is not suitable for filtering flammable gases or dusts.

The user must comply with the operating parameters specified in the operating instructions. The unit may only be used in accordance with its intended purpose. Any other use beyond this is not in accordance with the intended use. The user is liable for any damage or injuries of any kind resulting from such use.

#### **Authorised persons**

The following persons are authorised to handle the product:

- Specialist staff
  - Task: Maintenance and servicing
  - Qualification: trained specialist personnel (locksmith, industrial mechanic, electrician) with knowledge and experience in handling the machine.
- Operating personnel
  - Task: Operation
  - Qualification: training, information through operating instructions

Any other use is not in accordance with the intended use.

#### **Range of application**

The machine is intended for use in the following applications:

#### **Range of application**

- Refurbishments

## 5.2 Misapplication

Use of the machine for the following purposes is not permitted:

### **Reasonably foreseeable misuse**

- Any application other than that described in the operating instructions
- Any use of the machine other than that described under "Intended use" without the written consent of the manufacturer.
- Operation outside the technical limits of use
- Unauthorised modifications or conversions as well as manipulation
- Use, installation, operation, maintenance or repair in a manner other than described
- Carrying out work by unqualified personnel
- Use of unsuitable or incompatible materials, operating or auxiliary materials or accessories.
- Non-compliance with safety and operating instructions, occupational health and safety or accident prevention regulations or relevant statutory regulations.
- Failure to promptly rectify faults that may affect safety
- Use of other than original spare parts or accessories that are not equivalent in quality and function.
- Operating the machine in a technically unsound condition, not being aware of safety and hazards and not observing all instructions in the documentation.

### 5.3 Tasks and qualifications of the staff

| <b>Person</b>                  | <b>Task</b>                                                                                                                                         | <b>Required qualification</b>                                                                                                                                                                               |
|--------------------------------|-----------------------------------------------------------------------------------------------------------------------------------------------------|-------------------------------------------------------------------------------------------------------------------------------------------------------------------------------------------------------------|
| Operator                       | << Machine-specific >>                                                                                                                              | Instruction, training                                                                                                                                                                                       |
| Occupational safety specialist | <ul style="list-style-type: none"> <li>• Carry out a risk assessment</li> <li>• Create operating instructions</li> <li>• Instruct people</li> </ul> | Completed training as an occupational safety specialist with timely experience with machines                                                                                                                |
| Electrician                    | Installation and maintenance of electrical equipment                                                                                                | Person with appropriate training, suitable education, timely experience and knowledge of the relevant regulations, enabling him/her to recognise risks and avoid hazards that may be caused by electricity. |
| Freight forwarder              | Off-site transport of the machine                                                                                                                   | Person with suitable training, education, timely experience and knowledge of relevant regulations that enables them to safely transport machinery off-site.                                                 |
| Conveyor                       | Internal transport of the machine                                                                                                                   | Person with appropriate training, education, timely experience and knowledge of the relevant regulations that enables them to safely transport machinery within the company.                                |
| Disposer                       | Dispose of machine                                                                                                                                  | Qualified waste management company for legally compliant, proper and professional disposal of the machine                                                                                                   |

#### **5.4 Notes on occupational health and safety**

The operator of the machine is responsible for the implementation of the occupational health and safety obligations. The health and safety regulations of the country in which the machine is used apply.

The duties include, but are not limited to, the following:

- Provide these operating instructions or extracts to persons who carry out tasks with or in connection with the machine.
- Make the applicable documents available to these persons
- Instruction of the persons with regard to the intended use and misuse
- Instruction of persons with regard to protective devices and supplementary protective devices
- Instruction of persons with regard to residual risks

This list is not exhaustive and does not claim to be complete.



## 6 Transport

This section contains information on transporting the machine outside and inside the factory.

Transport is the change of location of the machine by manual or technical means.

### 6.1 Loss of warranty claims

The manufacturer's warranty will expire in the following cases:

- In the event of changes to the machine that have not been agreed with the manufacturer
- If the transport is not carried out properly

### 6.2 Off-site transport

#### 6.2.1 Transport space

Off-site transport takes place in the public space. In this case, the machine is transported from one place of use to another.

#### 6.2.2 Legislation

Off-site transport of the machine shall be in accordance with the legislation of the country in which the machine is transported off-site.

#### 6.2.3 Qualification of the staff

Persons transporting the machine outside the company must meet the following requirements:

| Person            | Required qualification                                                            |
|-------------------|-----------------------------------------------------------------------------------|
| Freight forwarder | Completed training in transport and experience in off-site transport of machinery |
| Logistician       | Completed training and experience in the internal transport of machines           |

#### 6.2.4 Warning of residual risks



Crushing hazard: Wear safety shoes to protect against running over limbs.

### 6.2.5 Means of transportation

For safe off-site transport, a means of transportation is required that meets the following requirements:

- The load capacity must be dimensioned in such a way that the mass of the machine can be safely accommodated.
- The size of the transport surface must be such that the machine can be safely placed on the transport surface without falling off.



Falling of the machine may be possible due to unintentional change of position when loading and unloading onto / from a means of transportation.

## 6.3 Internal transport

### 6.3.1 Transport space

In the case of in-plant transport, the machine is transported on the company premises from one installation site to another installation site.

### 6.3.2 Legislation

The internal transport of the machine is carried out in accordance with the legislation of the country in which the machine is transported outside the company.

### 6.3.3 Warning of residual risks



Crushing hazard: Wear safety shoes to protect against running over limbs.

### 6.3.4 Means of transportation

For safe internal transport, a means of transportation is required that meets the following requirements:

- The load capacity must be dimensioned in such a way that the mass of the machine can be safely accommodated.
- The size of the transport surface must be such that the machine can be safely placed on the transport surface without falling off.



Falling of the machine may be possible due to unintentional change of position when loading and unloading onto / from a means of transportation.

## 7 Assembly

This section contains information on the safe assembly of the machine.

The negative pressure unit is delivered ready for operation ex works and is intended for immediate commissioning.

If there is visible damage, **do not** operate the unit. Contact deconta GmbH immediately.

### HINWEIS

**Please note: In principle, the negative pressure unit can also be operated directly in the black area (positive pressure technology prevents contaminated ambient air from entering the housing).**

**However, since the units are contaminated from the outside and therefore require extensive cleaning after the remediation is completed, use in the black area should be avoided at all costs.**

- Integrate the unit into the partition wall between the white and renovation areas.
- Insert approx. 100 mm into the renovation area
- Seal unit with partition wall
- Route the exhaust air hose outside
- Ensure sufficient supply air in the renovation area

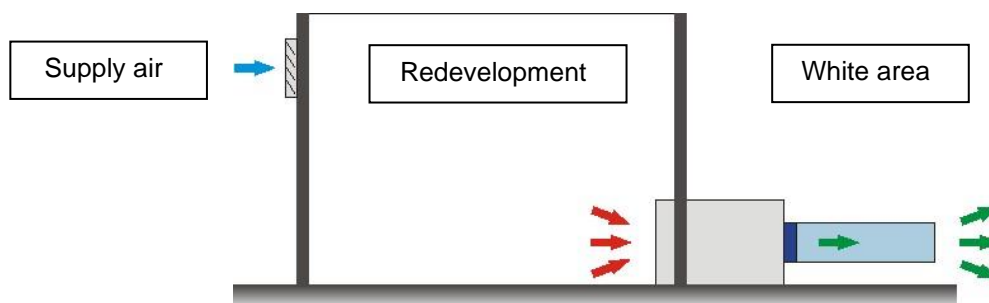

### ⚠ GEFÄHR

**Never use the unit without correctly installed filters approved for the respective requirement. Avoid blowing out unfiltered air.**

## 8 Operation

This section contains information for the safe use of the machine.

### 8.1 Qualification of the staff

Persons using the machine must meet the following requirements:

| Person   | Required qualification                    |
|----------|-------------------------------------------|
| Operator | Instruction, training by the manufacturer |

### 8.2 Warning of residual risks



Touching the cores of a damaged mains connection cable.

Touching machine parts that have become live due to faulty conditions.

Damage due to unsuitable mains voltage.



The unit may be damaged if it is connected to an unsuitable mains voltage.

Check whether the voltage indicated on the type plate corresponds to the local mains voltage.

The following materials must not be filtered:



- hot materials (smouldering cigarettes, hot ashes, etc.)
- flammable, explosive, aggressive materials and dusts

### 8.3 Personal protective equipment required

The following personal protective equipment is required for the use of the machine:

- If necessary, ear protection (for G 400 and G 500)

### 8.4 Number of persons

One person is needed to use the machine.

### 8.5 Tools needed

No tools are needed to use the machine.

### 8.6 Required equipment

No equipment is needed to use the machine.

## 8.7 Negative pressure unit with control SE

For power regulation, the negative pressure unit is supplied with a manual stepless control.

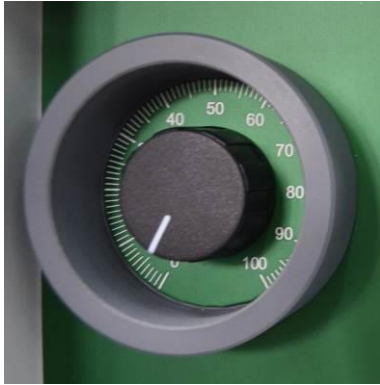

- Establish power connection
- Operate controller

### 8.7.1 Room negative pressure maintenance

- Set the desired negative pressure at the supply air opening or at the stepless regulator.
  - ⇒ Negative pressure too high:      Open the supply air opening or turn down the unit.
  - ⇒ Negative pressure too low:      Close the supply air opening or adjust the unit upwards.

**8.8 Negative pressure units with SRE connect control**

The connect functions are supported as standard in the following countries:

Albania, Algeria, Armenia, Aruba, Australia, Austria, Azerbaijan, Bangladesh, Belarus, Belgium, Bolivia, Bonaire, Bulgaria, Cambodia, China, Croatia, Curacao, Cyprus, Czech Republic, Denmark, El Salvador, Estonia, Faroe Islands, Finland, France, French Guyana, Georgia, Germany, Ghana, Gibraltar, Greece, Guadeloupe, Guyana, Honduras, Hong Kong, Hungary, Iceland, Indonesia, Ireland, Israel, Italy, Japan, Jersey, Kazakhstan, Kuwait, Kyrgyzstan, Laos, Latvia, Liechtenstein, Lithuania, Luxembourg, Macau, Macedonia, Malaysia, Malta, Martinique, Moldova, Mongolia, Montenegro, Nepal, Netherlands, Netherlands Antilles, New Zealand, Nigeria, Norway, Pakistan, Palestine, Panama, Papua New Guinea, Philippines, Poland, Portugal, Puerto Rico, Qatar, Romania, Russia, Saint Eustatius and Saba, Saint Martin (French part), Saint-Barthélemy, Serbia, Singapore, Slovakia, Slovenia, South Africa, South Korea, Spain, Suriname, Sweden, Switzerland, Taiwan, Tajikistan, Tanzania, Thailand, Tonga, Trinidad and Tobago, Tunisia, Turkey, Ukraine, United Kingdom, United States, Uzbekistan, Vietnam, Virgin Islands, U.S., Zambia

**All other countries not listed on request**

### 8.8.1 Create user account

Open the page [www.deconta-connect.com](http://www.deconta-connect.com) in your internet browser.

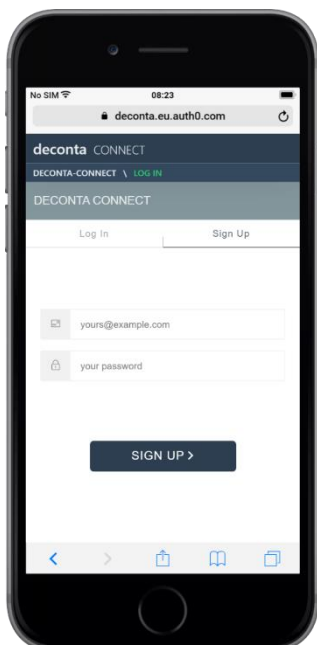

Tap on the "Sign Up" tab. Enter an email address and your desired password.

The password must be at least 8 characters long and meet 3 of the following 4 criteria:

- at least 1 number
- at least 1 capital letter
- at least 1 lower case letter
- at least 1 special character.

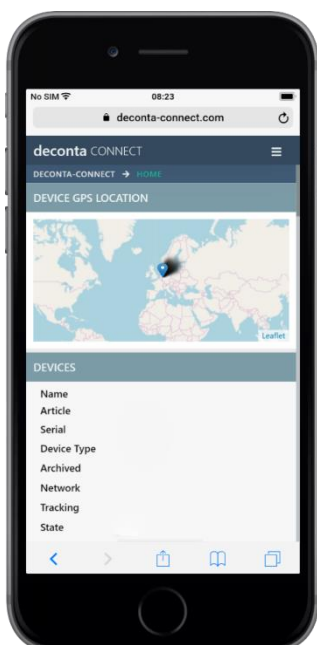

You will see this page after successful registration.

Any number of devices can now be assigned to the user account.

8.8.2 Add the machine to the user account

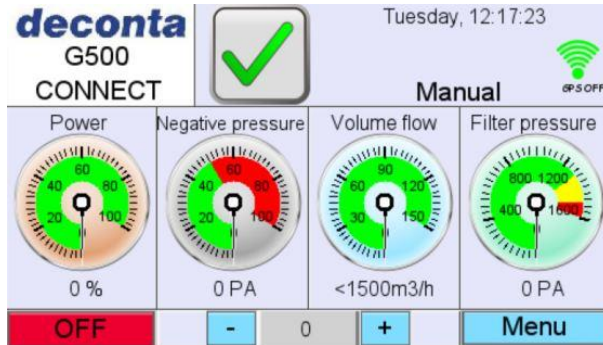

Switch on the unit.  
Tap the "Menu" button.

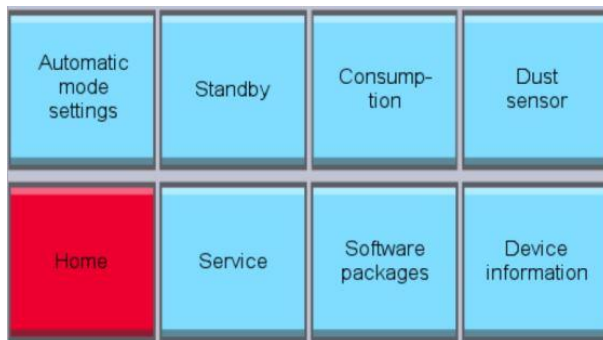

Tap the "Service" button

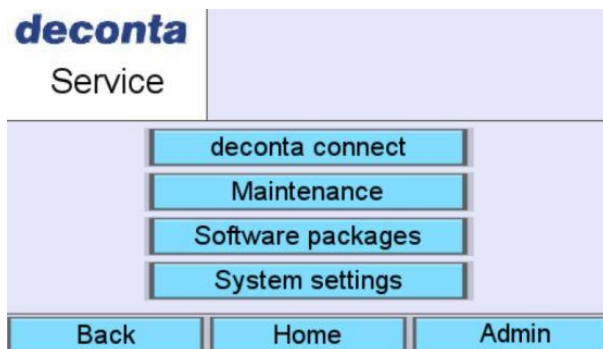

Tap the "deconta connect" button.



The page with a QR code and a key underneath is displayed.



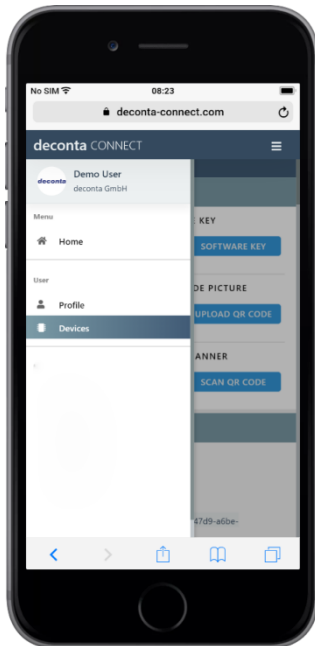

Log in to the connect page with your email address and password.

Tap on the menu icon  and then on "Devices".

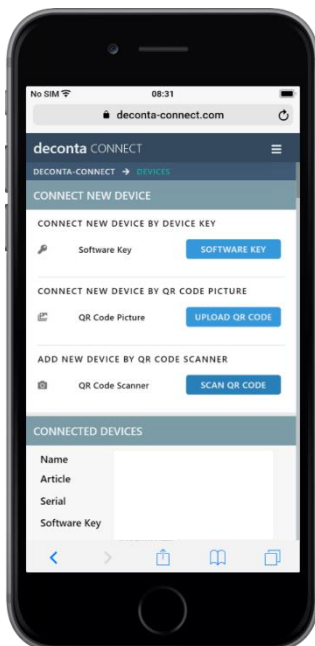

Tap on the button "SCAN QR CODE (our recommendation) or alternatively on the button "SOFTWARE KEY".

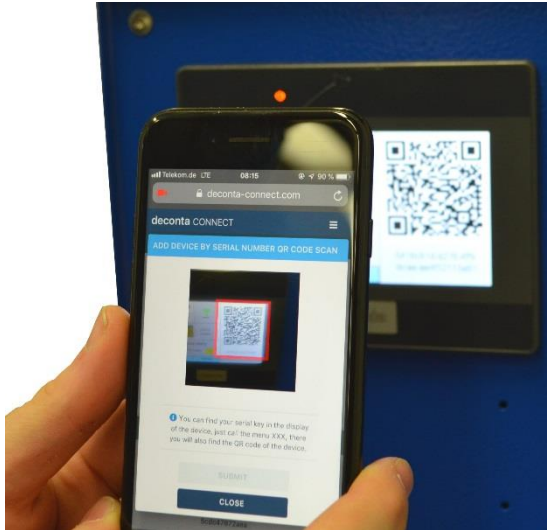

Scan the QR code that appears in the display of the unit.

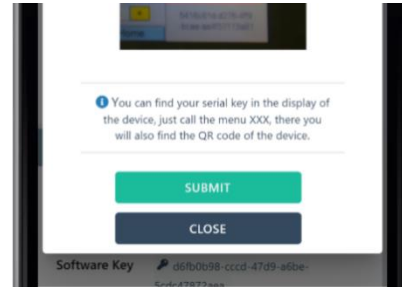

If the QR code is recognised, the "SUBMIT" button changes to green. To add, tap this button, the device is now registered in your user account.

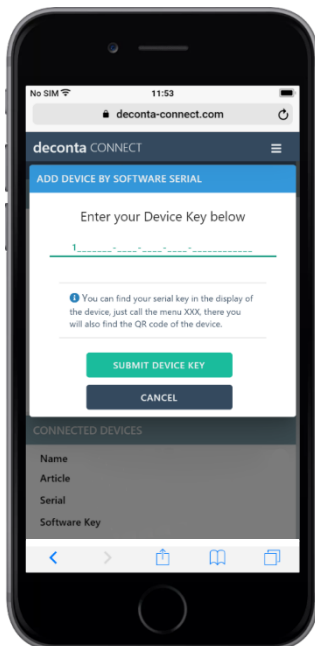

Alternative registration via the "SOFTWARE KEY" button

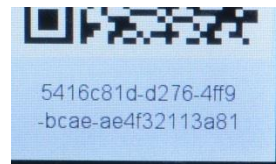

Enter the key that is displayed below the QR code on the device in the field provided and then tap the green button "SUBMIT DEVICE KEY", the device is now registered in your user account.

### 8.8.3 Preparation

Determine the measuring point in the black area and connect it with PE hose 8 x 1 to the negative pressure connection "-".

Determine the measuring point in the white area (adjacent rooms) and connect it to the atmosphere "+" connection with PE hose 8 x 1.

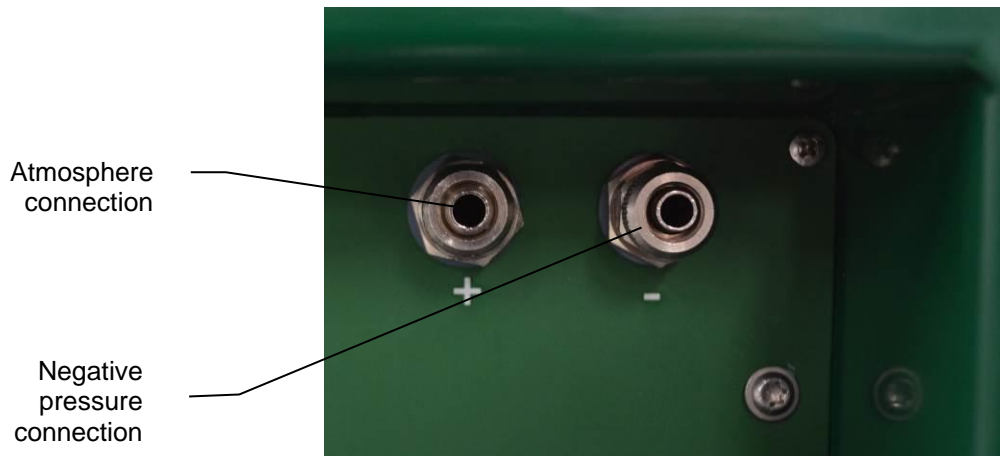

The control can be used in 2 different operating modes.

### 8.8.4 Manual operation

In manual mode, the "-" and "+" keys are used to set the fan power.

The display shows the power value in % (Power), the measured negative pressure in Pa, the volume flow in m<sup>3</sup>/h and the filter pressure in Pa.

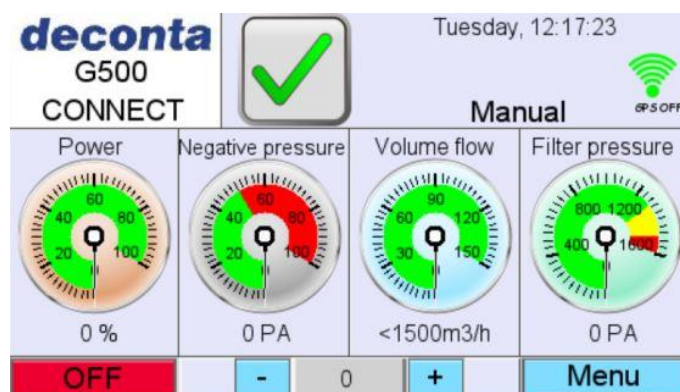

8.8.5 Automatic operation

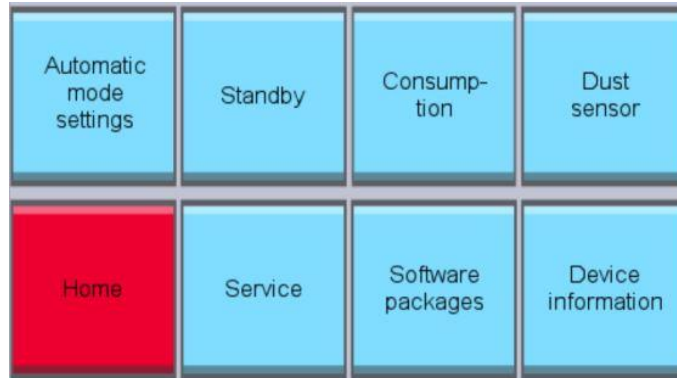

To make the settings and to switch automatic mode on or off, press the "Menu" button. In the following menu, press the button "Automatic mode settings".

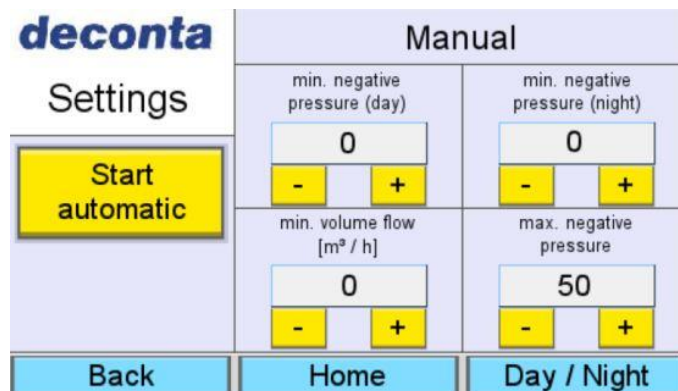

The following parameters can be set:

- Minimum negative pressure in day mode (min. negative pressure day)
- Minimum negative pressure in night mode (min. negative pressure night)
- Minimum volume flow in m<sup>3</sup>/h (min. volume flow)
- Maximum negative pressure (max. negative pressure)

Automatic operation is started by tapping the "Start automatic" button.

By comparing the entered setpoint with the permanently measured current actual value, the speed of the fan is automatically adjusted, i.e. the fan automatically "goes up" or "goes down".

8.8.6 Day / Night Settings (Day / Night)



By selecting time ranges, you can set here on which days and at which time the value set in automatic mode for the minimum negative pressure in night mode (min. negative pressure night) is activated.

8.8.7 Standby mode

A negative pressure unit with SRE connect control can be operated as a standby unit. If this function is activated, the unit switches on automatically if the vacuum falls below a previously defined level (e.g. if the actual vacuum maintenance unit fails).

The standby mode is switched on in the menu by tapping the "Standby" button.

In the Standby waiting time field, a delay of 0-600 seconds for switching on can be entered.

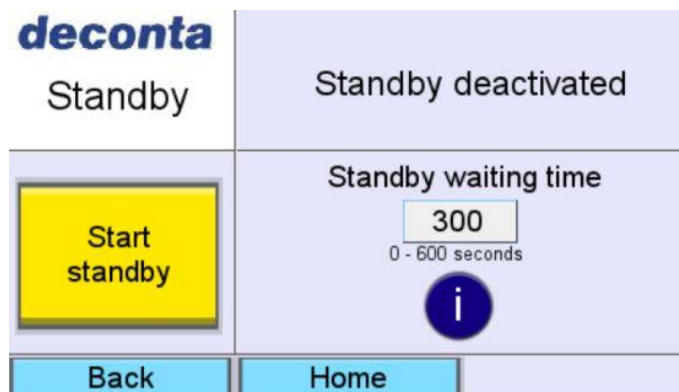

8.8.8 Consumption

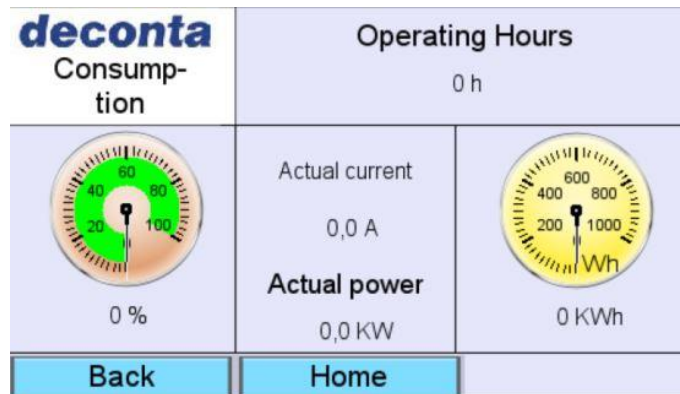

Left: the current power of the unit is shown here in %.

Top centre: Display of the current power consumption (Actual current) in A

Bottom centre: Display of the current power (Actual power) in kW

Right: display of Wh and below that the total consumption in KWh

8.8.9 Dust Sensor

A filter sensor monitors the particle concentration in the exhaust air.

The functions and the status of the filter sensors are shown in the display.

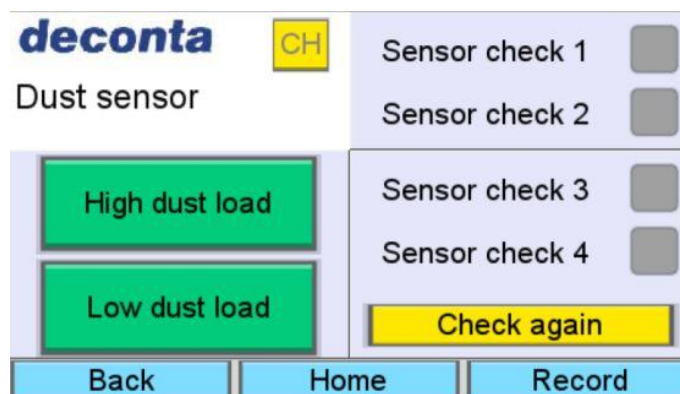

The measured values of the filter sensors can be displayed graphically via the "Record" button.

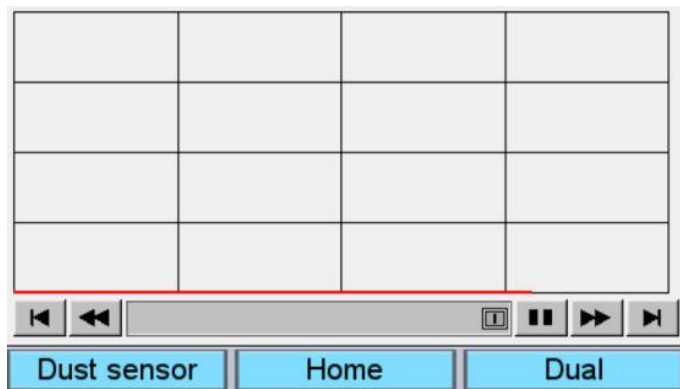

### 8.8.10 Service

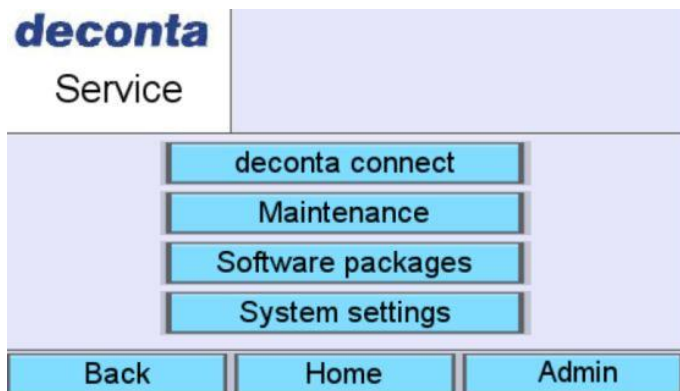

#### deconta connect

Assigning a device to a connect account, see 8.8.1.

#### Maintenance

Settings in this menu can only be made by qualified deconta service partners.

Software packages

Display of the booked options and the expiry date of the licences.

| deconta<br>Software packages             |          |
|------------------------------------------|----------|
| connect BASIC                            | 25.02.44 |
| Particle Sensor                          | 28.02.25 |
| connect Pro                              | 28.02.25 |
| includes connect BASIC & Particle Sensor |          |
| Back                                     | Home     |
| Set payments                             |          |

System settings

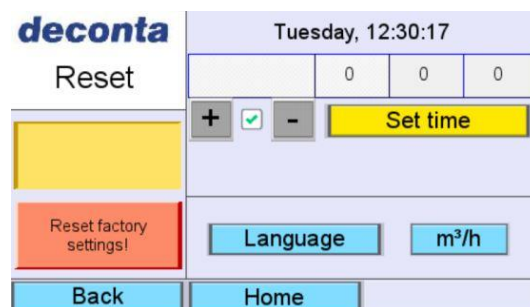

Setting the day of the week and time. These values are shown on the unit display and are required for the Day / Night settings.

Data sent to the connect user account is displayed there in the set time zone (by default UTC ±0 = coordinated world time).

By tapping the yellow button "Reset factory settings? (reset to factory settings?) the red button "Reset factory settings!" is activated.



**Tapping this red button resets all settings to factory defaults!**



Setting the language. Tapping the "Language" button takes you to the menu for setting the display language. Selectable languages: English, German, French, Italian, Spanish, Japanese, Dutch and Portuguese.

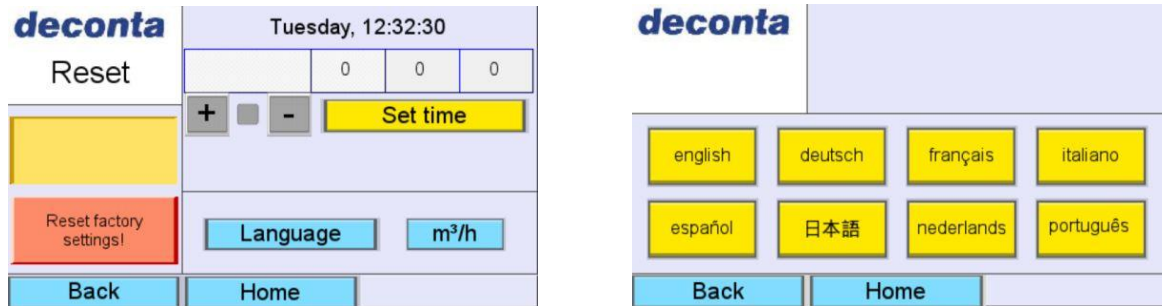

By tapping the m<sup>3</sup>/h button, the unit can be changed to m<sup>3</sup>/min.

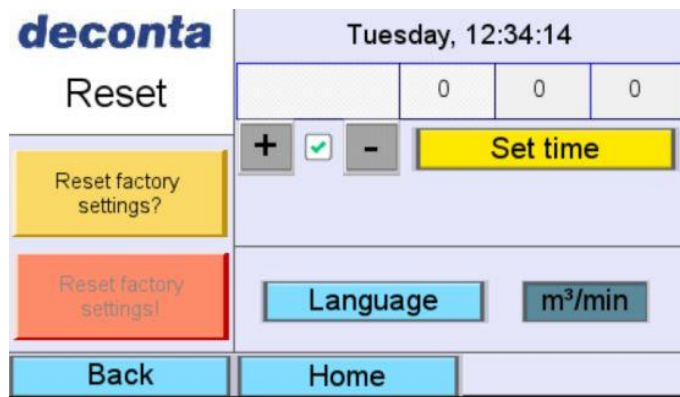

8.8.11 Device information

Display of unit information.



### 8.8.12 Alarms

Alarms are displayed visually via a flashing symbol on the main screen, at the same time an acoustic signal sounds. There are 3 different displays:

- Green tick: no alarm message is present



- Yellow bell: There was an alarm, but it no longer exists and has not yet been acknowledged.



- Red bell: there is an acute alarm message



A submenu with more detailed information on alarms can be called up by tapping the button with the green tick, the yellow bell or the red bell.

Alarms are displayed with a red button.

After the fault has been eliminated, the alarm must be acknowledged by tapping the respective button, the colour changes to green.

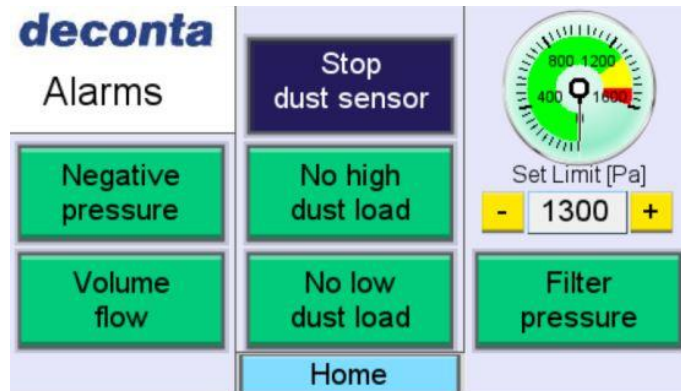

**Negative pressure:**

- the setpoint for the minimum negative pressure could not be reached.

**Volume flow:**

- the setpoint for the minimum volume flow could not be reached.

**High dust load:**

- Message filter sensor in case of many particles within a short period of time

**Low dust load:**

- Message filter sensor in case of few particles over a longer period of time

**Filter pressure:**

the alarm value for the filter pressure can be adjusted continuously with the "-" and "+" keys (yellow range in the display = filter must be replaced soon). The red range is fixed at the factory.

**Stop dust sensor / Start dust sensor:**

- Switching the dust sensors on / off.

**HINWEIS**

**When the sensors are switched off, the particle concentration in the exhaust air is not monitored!**

8.8.13 Switch off the unit

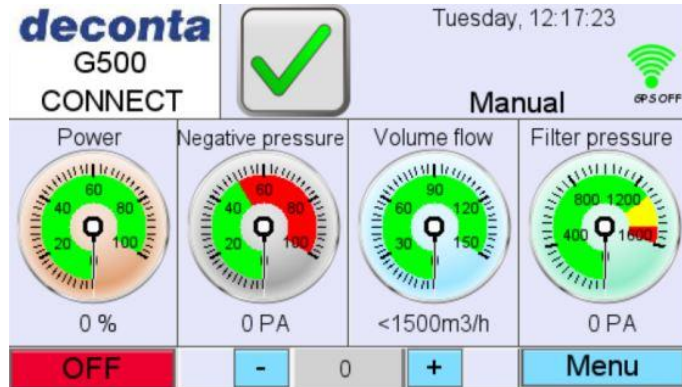

To switch off the unit, tap the red "OFF" button.

**deconta**

**Shut down**

The unit switches off and the mains plug can be pulled out.

**deconta**

Pull power  
cable



## 9 Maintenance

This section contains information for the safe maintenance of the machine.

Maintenance includes all technical and organisational measures during the life cycle of the machine to ensure the safe, economical and functional condition of the machine and to prevent environmental damage.

### 9.1 Loss of warranty claims

The manufacturer's warranty will expire in the following cases:

- In the event of modifications to the machine that have not been agreed with the manufacturer
- If maintenance is not carried out properly

### 9.2 Maintenance

Maintenance work, including changing / removing the filters, may only be carried out by authorised persons wearing suitable protective clothing.

For all repair and maintenance work, the unit must be completely disconnected from the power supply.

**We expressly refer to possible additional regional and national regulations when maintaining the appliance technology.**

The ventilation systems (dust extractors, industrial hoovers and devices used for ventilation or vacuum maintenance) must be maintained as required, but at least once a year, repaired if necessary and inspected by an equipment expert. The test result must be presented on request.

**Units with SRE connect control should be checked and calibrated once a year by deconta service.**

### 9.3 Warning of residual risks



**Contaminated filters may only be changed in compliance with all relevant safety precautions.**

**Change filters only when the unit is switched off. Only use approved filters.**



**Do not use residual fibre binders on the unit.**



**Pull out the mains plug before opening the housing**

9.3.1 Personal protective equipment required



**Maintenance work, including changing / removing the filters, may only be carried out by authorised persons wearing suitable protective clothing.**

**9.4 Filter change information**

The frequency of the filter change depends on the degree of contamination of the filters. With increasing filter occupancy (soiling of the filters), the air performance decreases.

For filter monitoring during operation, a pressure gauge is fitted on units with SE control, on units with SRE connect control the filter monitoring is shown in the display.

9.4.1 Control SE



The following table shows the display values for a recommended filter change. If the display reaches this value, please change the pre-filters and intermediate filters first. If the display value drops by 100 Pascal or more, the unit can continue to be operated. If the value drops by less than 100 Pascal, the HEPA filter must be replaced.

| Device | Recommended filter change at |                     |
|--------|------------------------------|---------------------|
|        | 110 V                        | 230 V               |
| G 50   | approx. 700 Pascal           | approx. 800 Pascal  |
| G 100  | approx. 700 Pascal           | approx. 1000 Pascal |
| G 200  | approx. 700 Pascal           | approx. 1100 Pascal |
| G 300  | approx. 700 Pascal           | approx. 1100 Pascal |
| G 400  | ---                          | approx. 1200 Pascal |
| G 500  | ---                          | approx. 1300 Pascal |

9.4.2 Control SRE connect

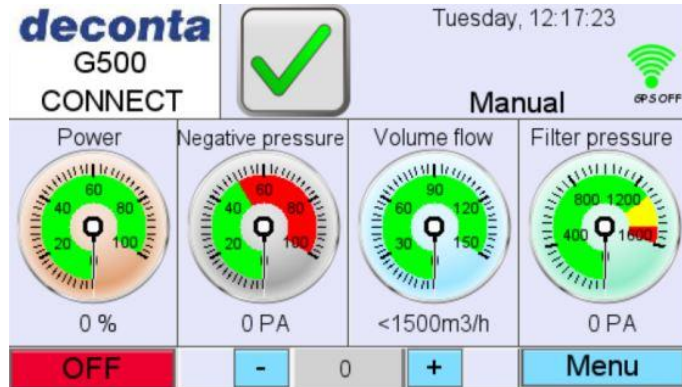

For filter monitoring, the filter pressure is shown in the display of the control unit. If the display reaches the red area, please replace the pre-filters and intermediate filters first. If the display value drops by 100 Pascal or more, the unit can continue to be operated. If the value drops by less than 100 Pascal, the HEPA filter must be replaced.

9.5 Filter change



**Contaminated filters may only be changed in compliance with all relevant safety precautions. Change filters only when the unit is switched off. Only use approved filters.**



**Do not use residual fibre binders on the unit.**



**Pull out the mains plug before opening the housing**



**Maintenance work, including changing / removing the filters, may only be carried out by authorised persons wearing suitable protective clothing.**

9.5.1 Procedure using the G 300 as an example

- Loosen the tension locks and remove the hose connection flange / transport cover.

**HINWEIS**

**Danger of fingers being crushed when opening and closing the tension locks**

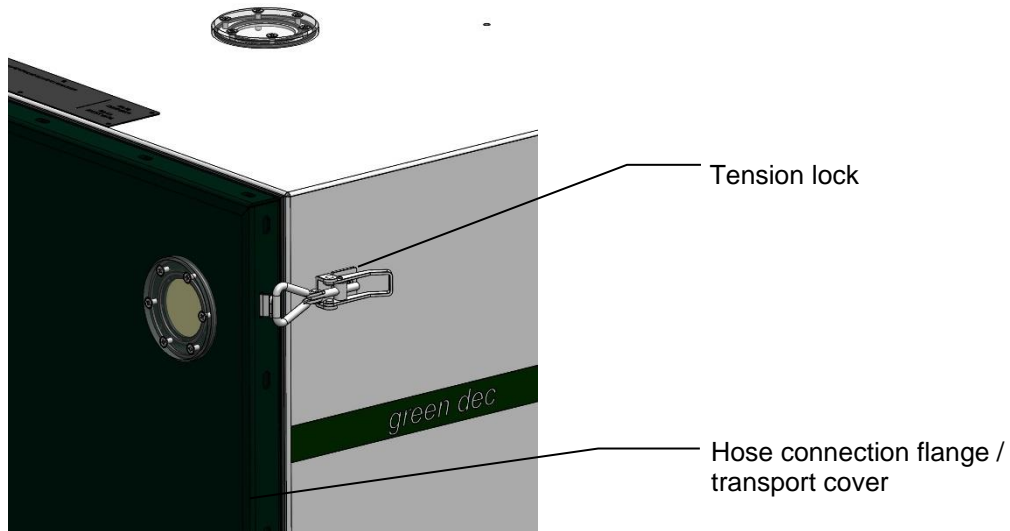

- Remove the pre-filter and intermediate filter and dispose of them in accordance with the regulations.

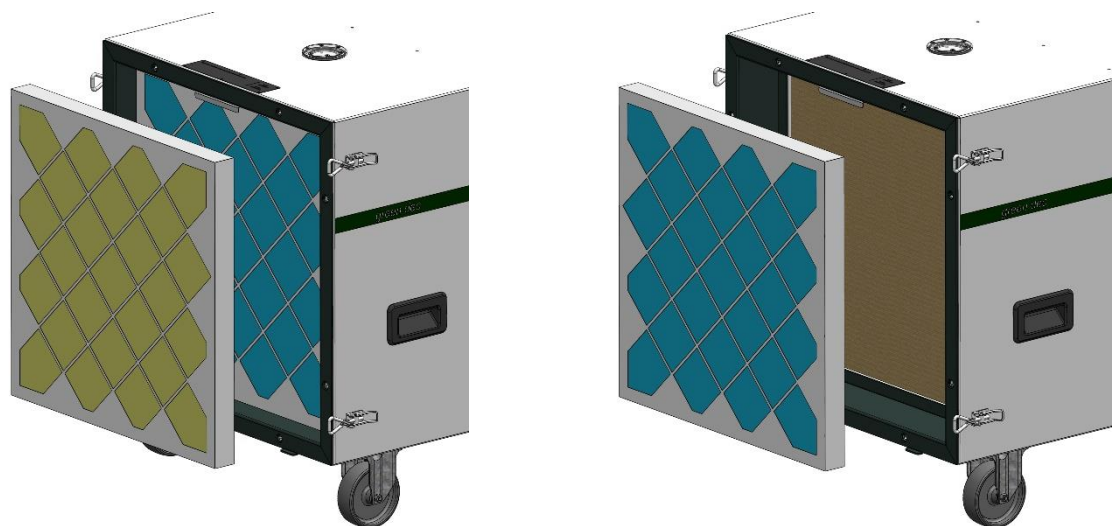

*Pre-filter/Intermediate filter*



- Unscrew the Torx screws of the clamping frame with the Torx screwdriver supplied.

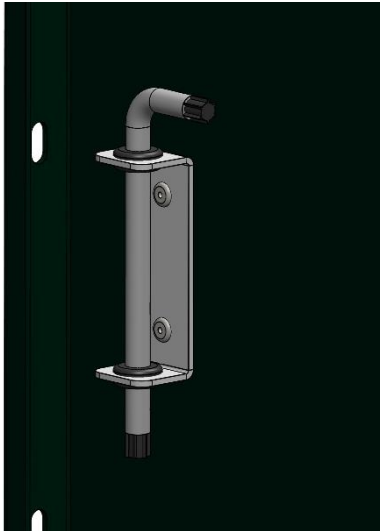

Torx screw

Clamping frame



- Remove clamping frame

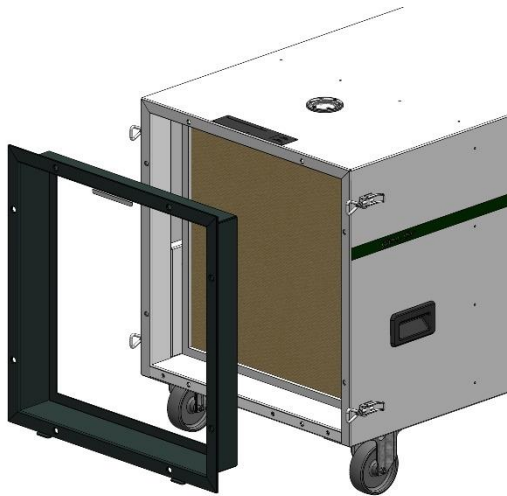

- Remove the HEPA filter and dispose of it in accordance with the regulations.

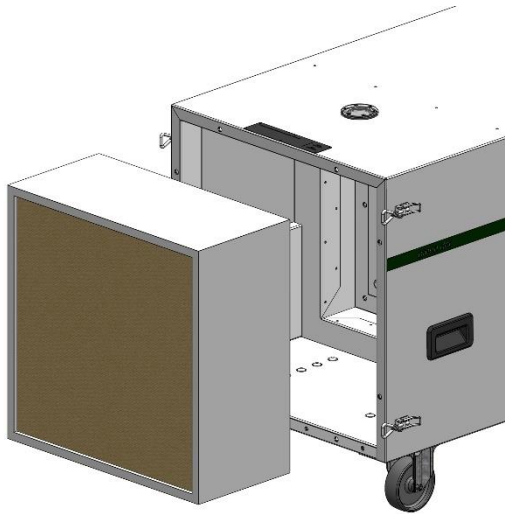

- Check and clean the sealing surface on the unit

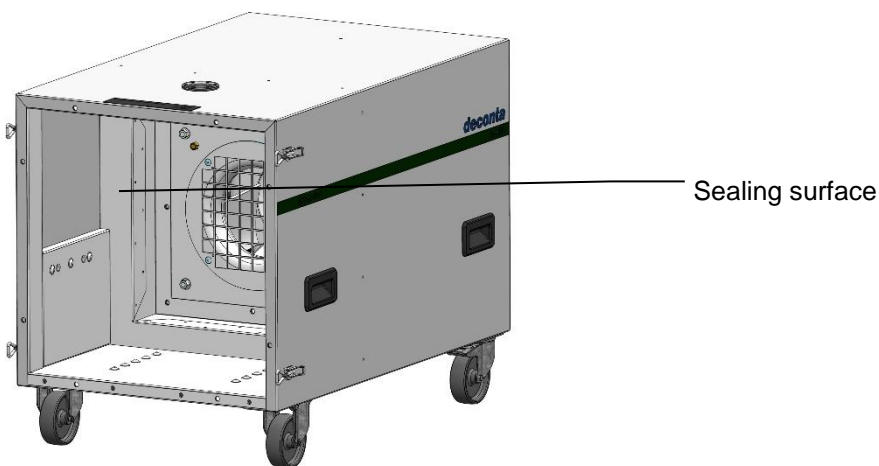

- Clean the inside of the housing and insert a new main filter in the **centre**.
- Insert clamping frame and Torx screws (tighten screws evenly)
- Use pre- and intermediate filters
- Mount the hose connection flange

**HINWEIS**

**The units have only been tested with original deconta HEPA filters. To ensure machine safety, only original deconta filters should be used. If this is not observed, machine safety cannot be guaranteed. This can result in the unintentional and uncontrolled release of hazardous substances into the environment due to filter overload (leakage, filter rupture, ...).**

## 9.6 Troubleshooting and fault clearance

This section contains information on safe troubleshooting of the machine.

### 9.6.1 Possible malfunctions and tips for rectifying malfunctions

The following table gives an overview of malfunctions and measures to remedy them.

| <b>Malfunction</b>        | <b>Possible cause</b>                              | <b>Measure</b>                                                          |
|---------------------------|----------------------------------------------------|-------------------------------------------------------------------------|
| Negative pressure too low | Pre- / intermediate or main filter dirty           | Change filter as described under 9.5                                    |
| Unit does not work        | Power source not in order                          | Have the power source inspected and repaired by a qualified electrician |
| Unit does not work        | Components on the negative pressure unit defective | Have the unit repaired by deconta or a workshop authorised by deconta.  |

## 10 Spare parts

For safe, trouble-free and economical use of the machine, original spare parts should be used.

If this is not possible, the alternative spare parts should correspond to the characteristics of the original spare parts in order to ensure the safe, trouble-free and economical use of the machine.

### 10.1 Negative pressure unit green dec G 50

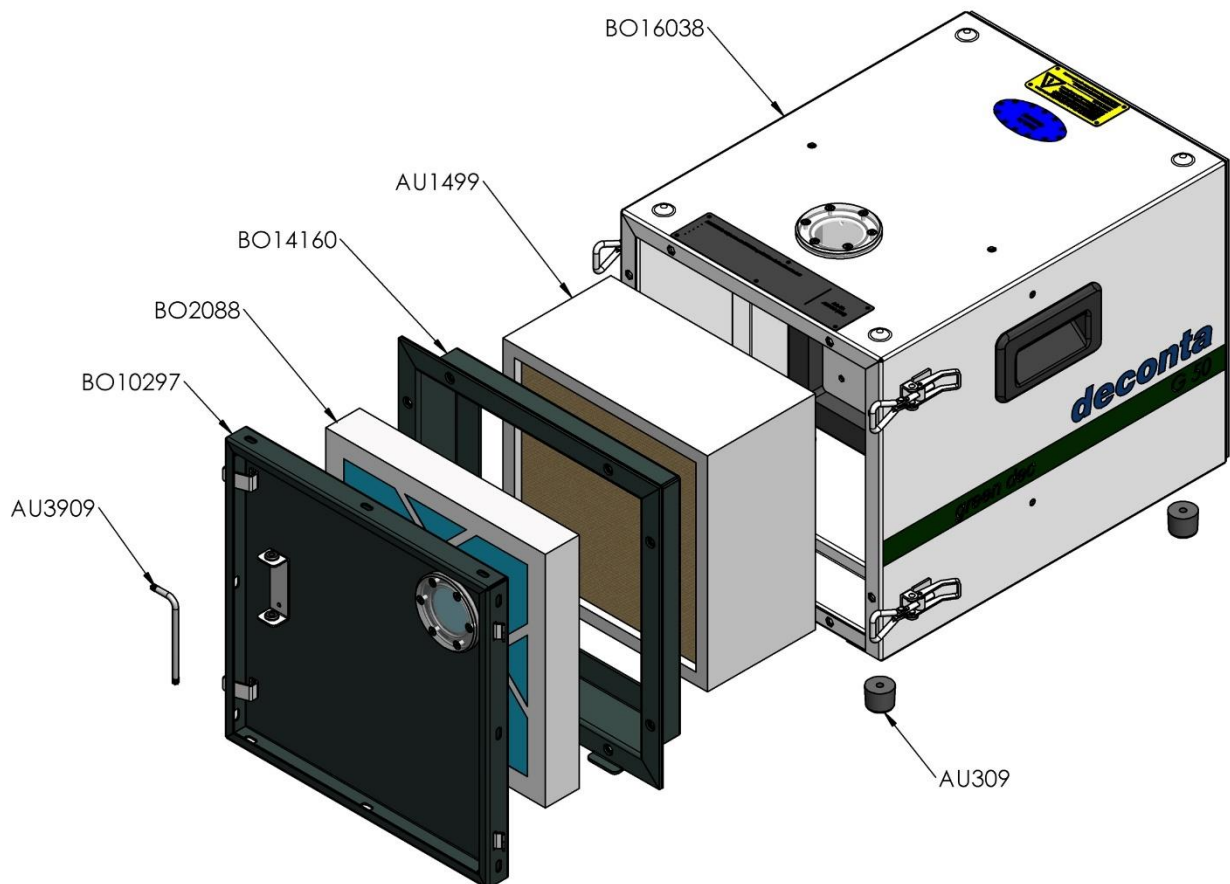

## 10.2 Negative pressure unit green dec G 100

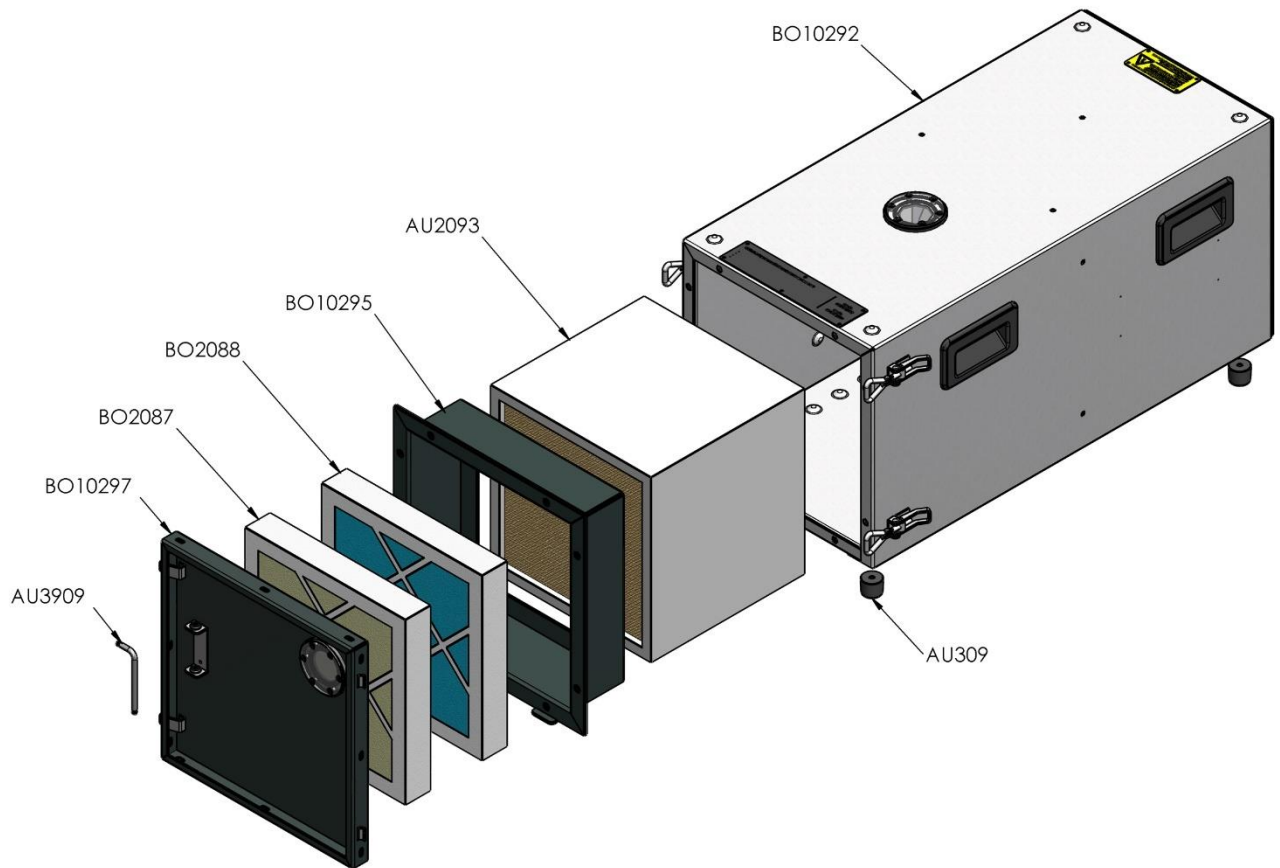

### 10.3 Negative pressure unit green dec G 200

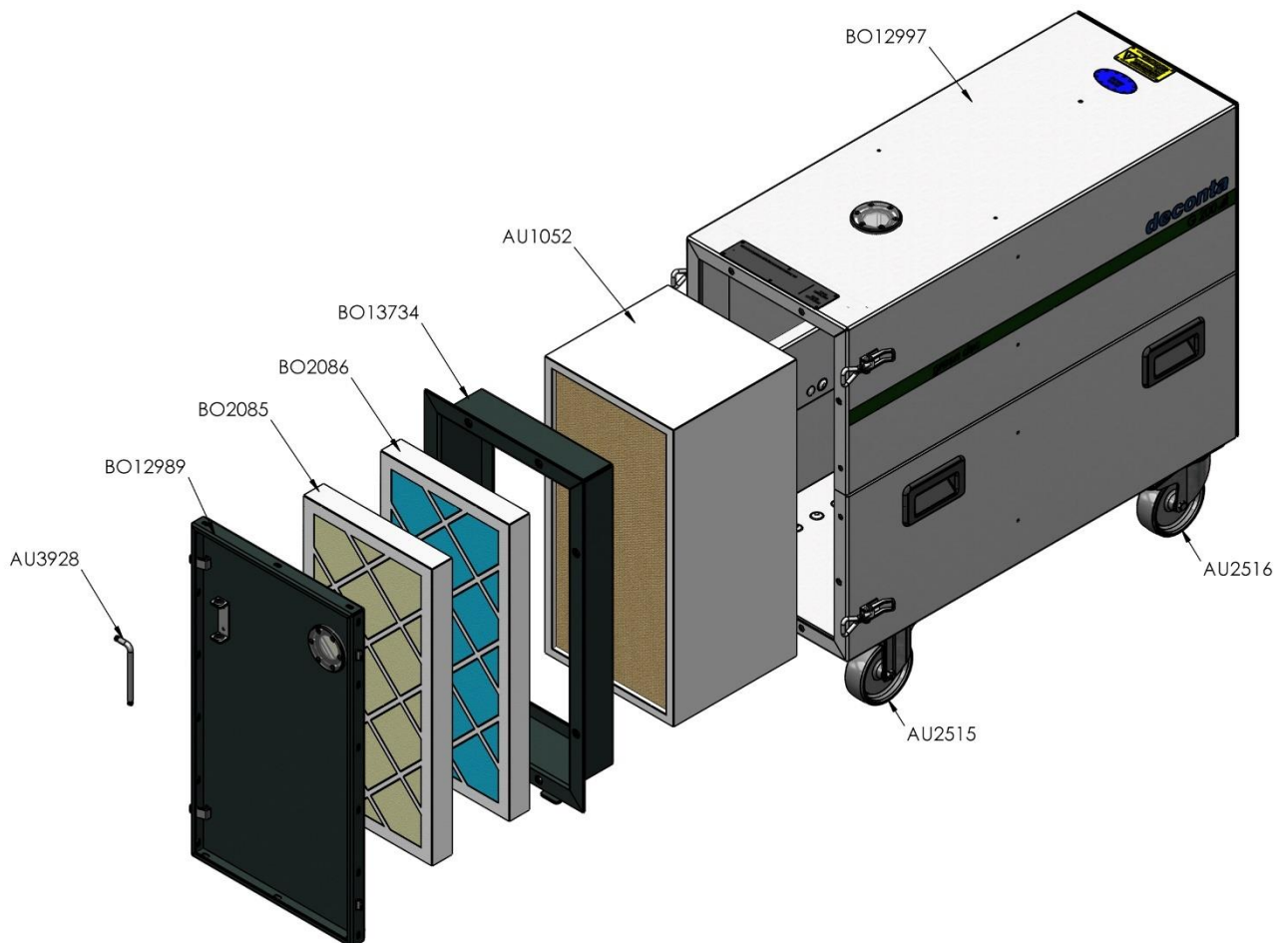

### 10.4 Negative pressure unit green dec G 300

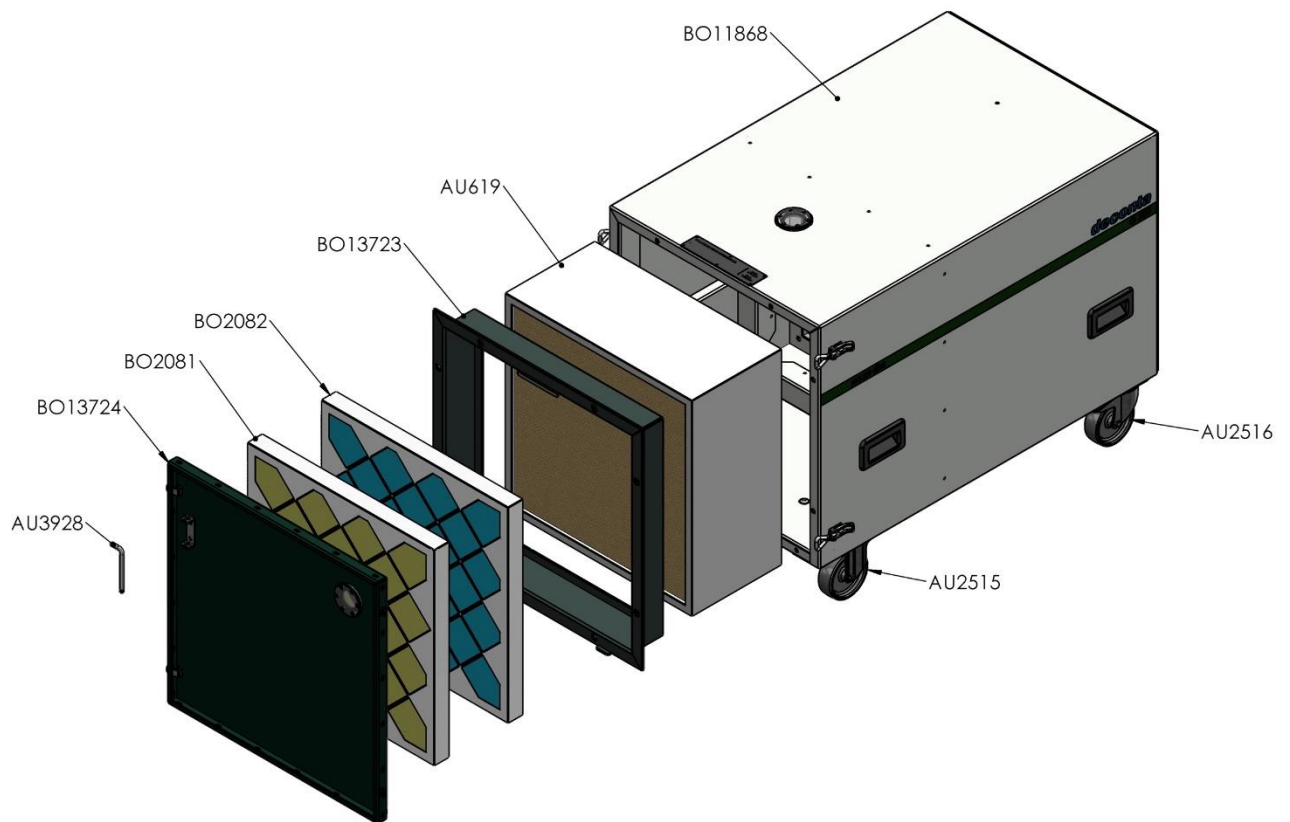

### 10.5 Negative pressure unit green dec G 400

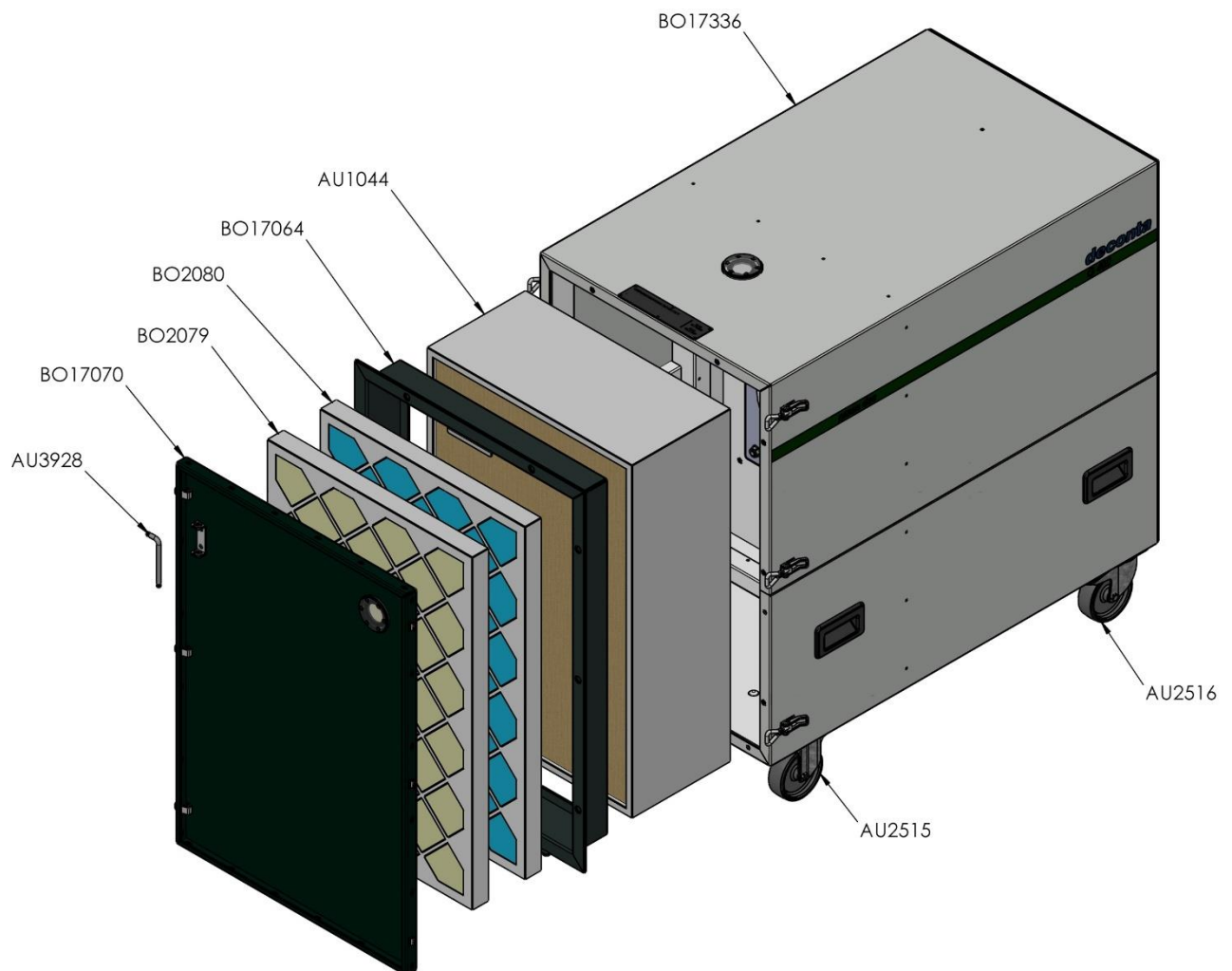



### 10.6 Negative pressure unit green dec G 500

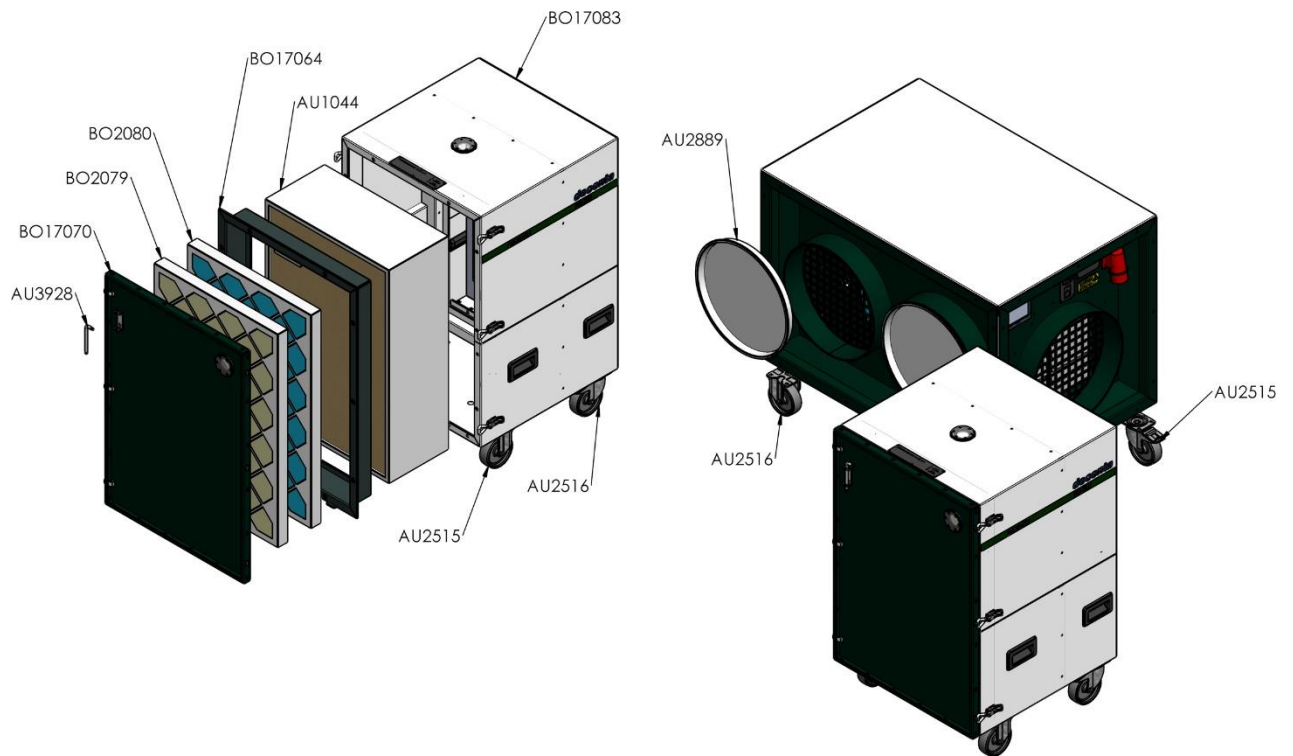

# 11 Circuit diagrams

## 11.1 Negative pressure unit green dec G 50 SE, 110 volt version

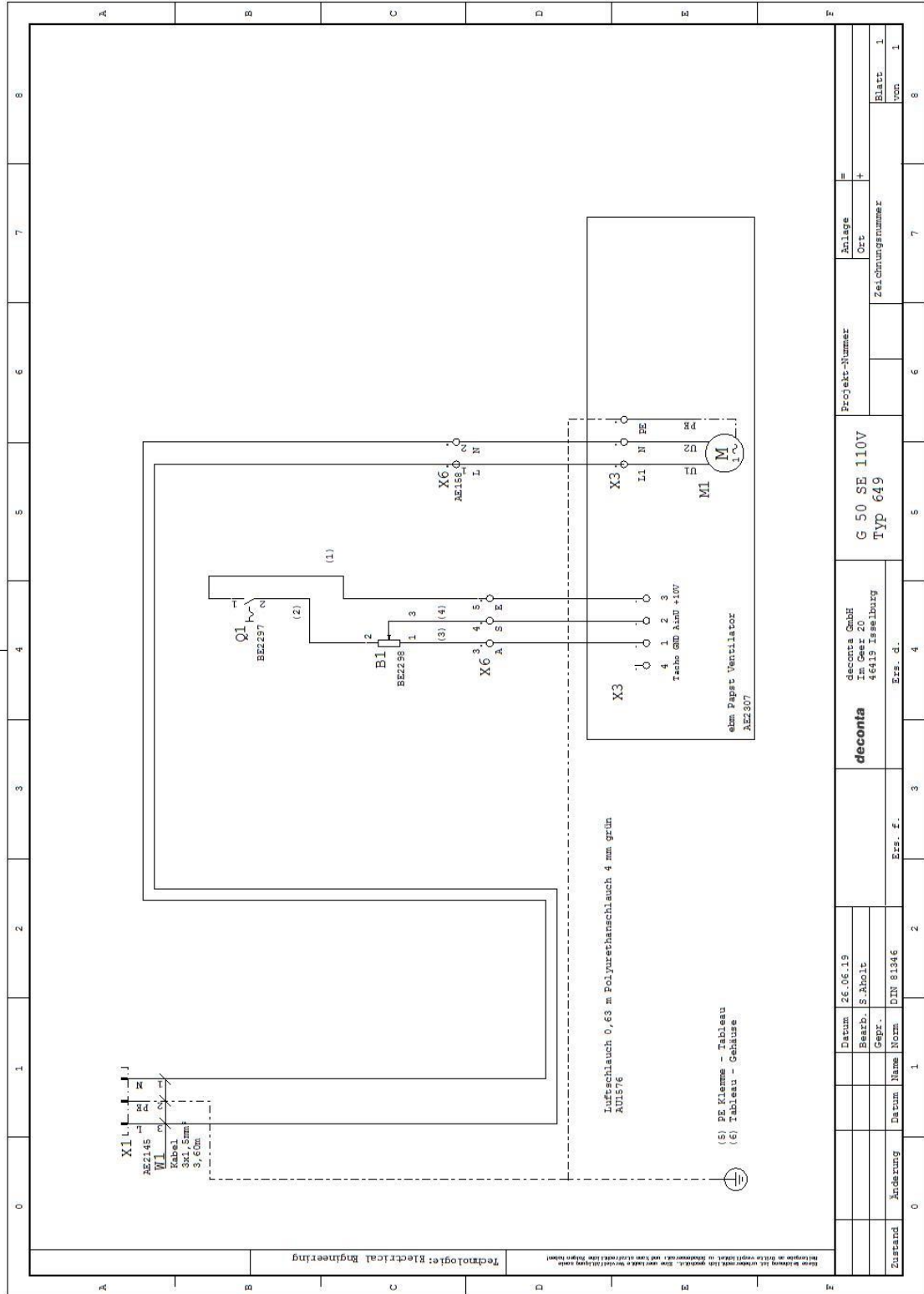

**11.2 Negative pressure unit green dec G 50 SE, 230 volt version**

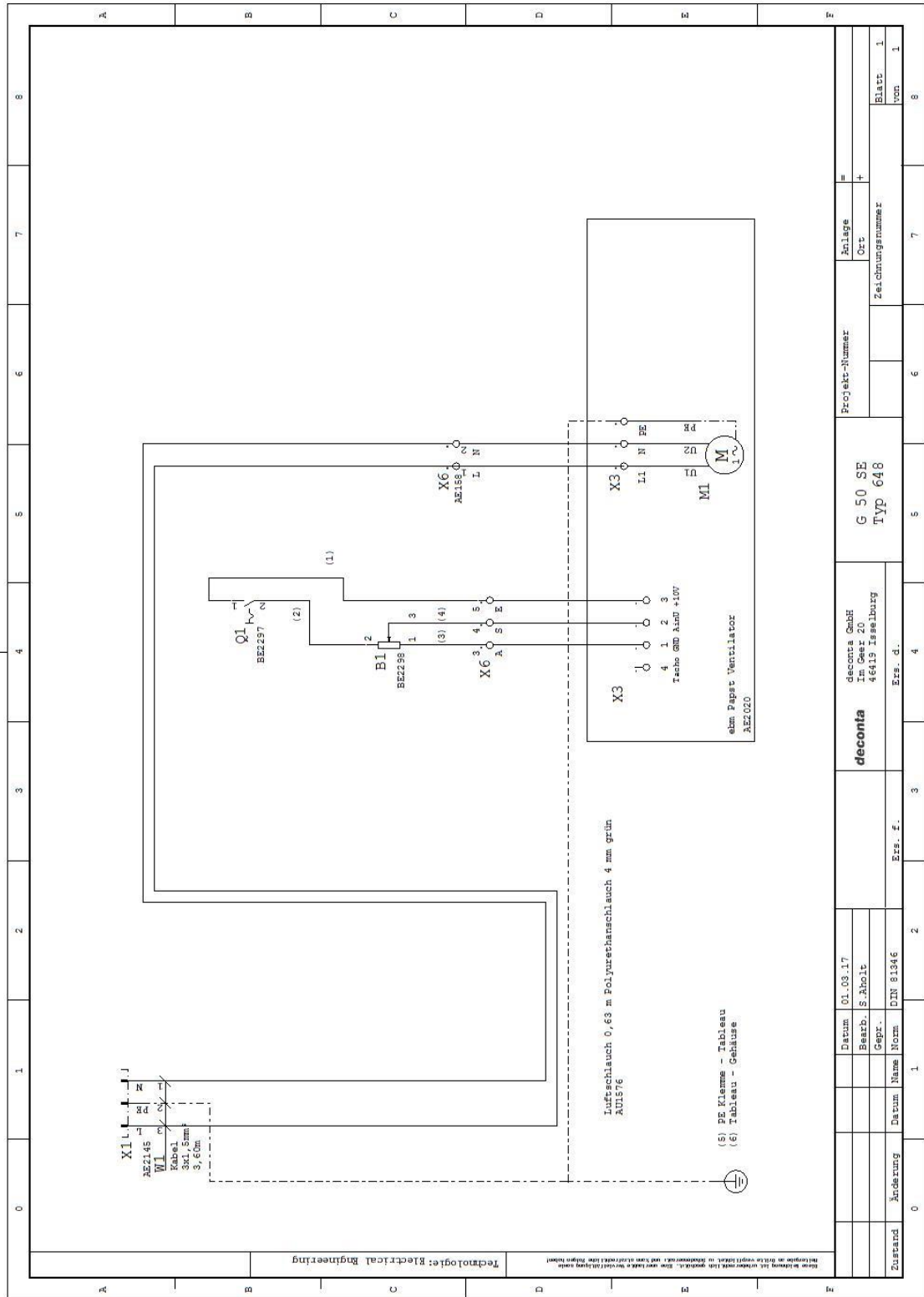

|         |  |          |  |          |          |      |           |         |         |                                         |  |                    |  |               |  |                                     |  |                |  |  |
|---------|--|----------|--|----------|----------|------|-----------|---------|---------|-----------------------------------------|--|--------------------|--|---------------|--|-------------------------------------|--|----------------|--|--|
| Zustand |  | Änderung |  | Datum    | Name     | Norm | DIN 51346 | Ers. f. | Ers. d. | deconta<br>in Gear 20<br>46119 Iseeburg |  | G 50 SE<br>Typ 648 |  | Anlage<br>Ort |  | Projekto-Nummer<br>Zeichnungsnummer |  | Blatt<br>von 1 |  |  |
|         |  |          |  | 01.03.17 | S. Abolt |      |           |         |         |                                         |  |                    |  |               |  |                                     |  |                |  |  |

11.3 Negative pressure unit green dec G 100 SE, 110 volt version

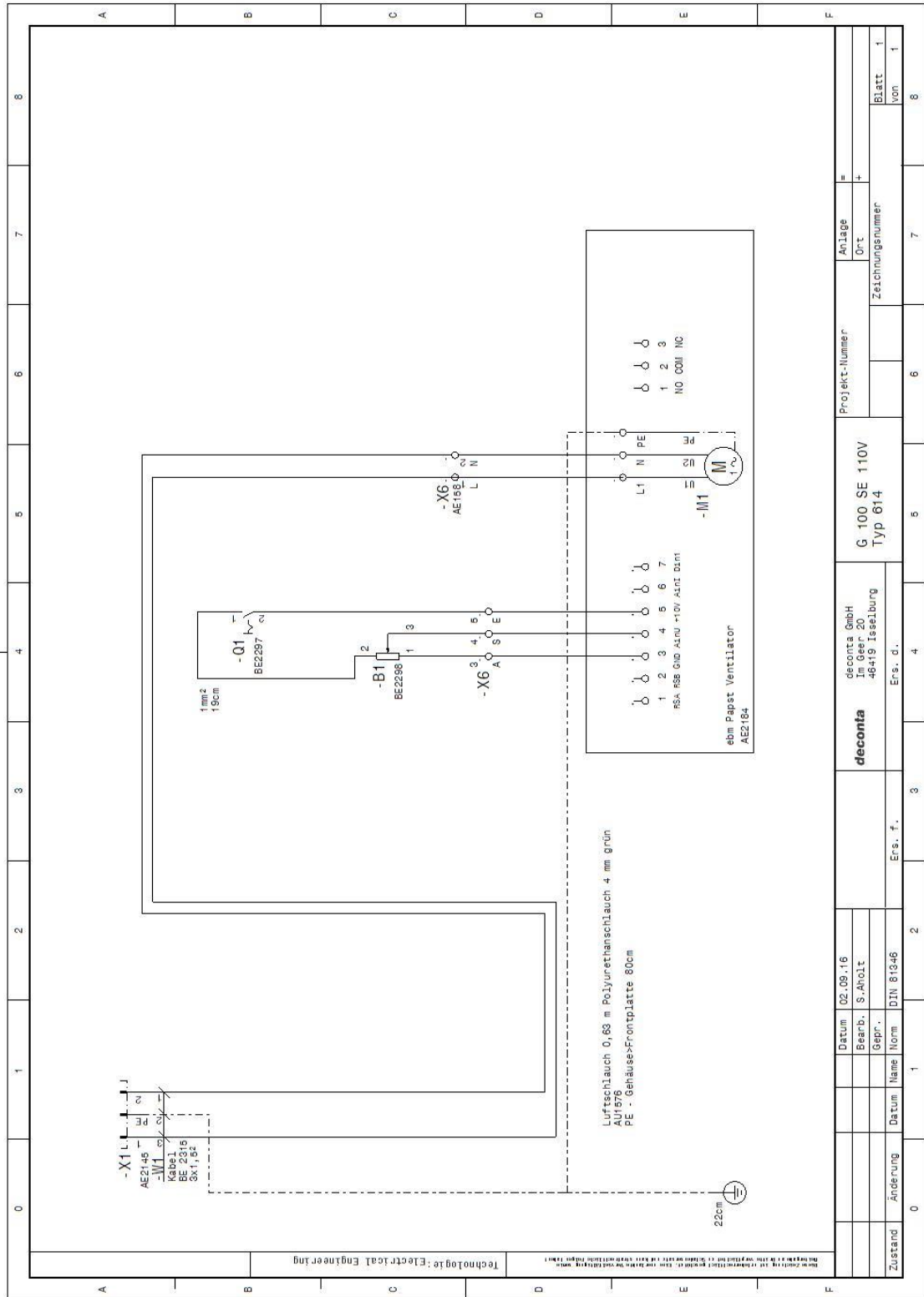



**11.5 Negative pressure unit green dec G 100 SRE connect, 230 volt version**

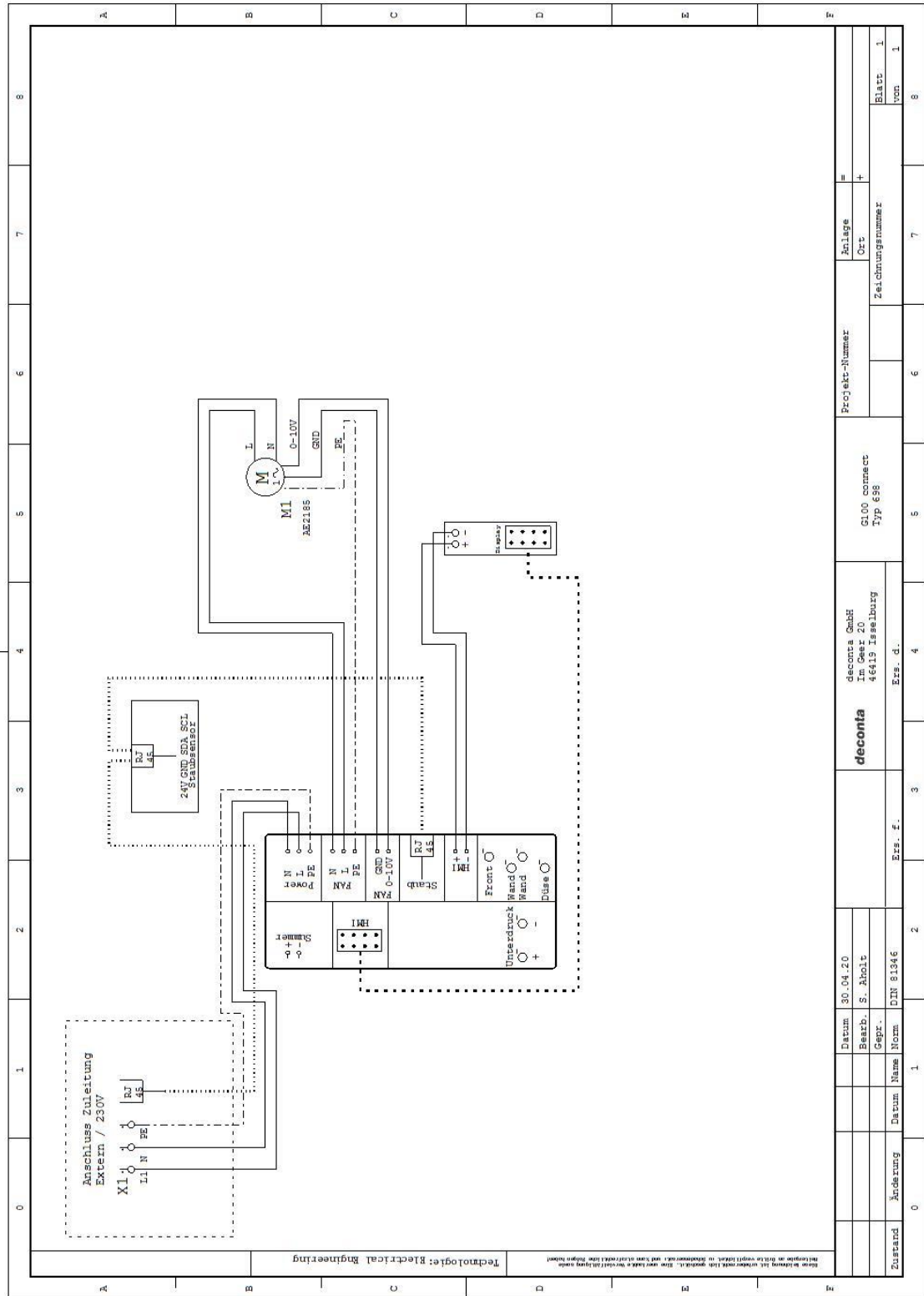

|         |  |          |  |       |  |      |  |      |  |           |  |         |  |         |  |         |  |                                              |  |                         |  |                 |  |               |  |              |  |  |  |
|---------|--|----------|--|-------|--|------|--|------|--|-----------|--|---------|--|---------|--|---------|--|----------------------------------------------|--|-------------------------|--|-----------------|--|---------------|--|--------------|--|--|--|
| Zustand |  | Änderung |  | Datum |  | Name |  | Norm |  | DIN 81346 |  | Err. f. |  | Err. d. |  | deconta |  | deconta GmbH<br>in Gear 20<br>46415 Iseeburg |  | G100 connect<br>Typ 699 |  | Projekto-Nummer |  | Anlage<br>Ort |  | Blatt<br>von |  |  |  |
|         |  |          |  |       |  |      |  |      |  |           |  |         |  |         |  |         |  |                                              |  |                         |  |                 |  |               |  |              |  |  |  |

**11.6 Negative pressure unit green dec G 200 SE, 110 volt version**

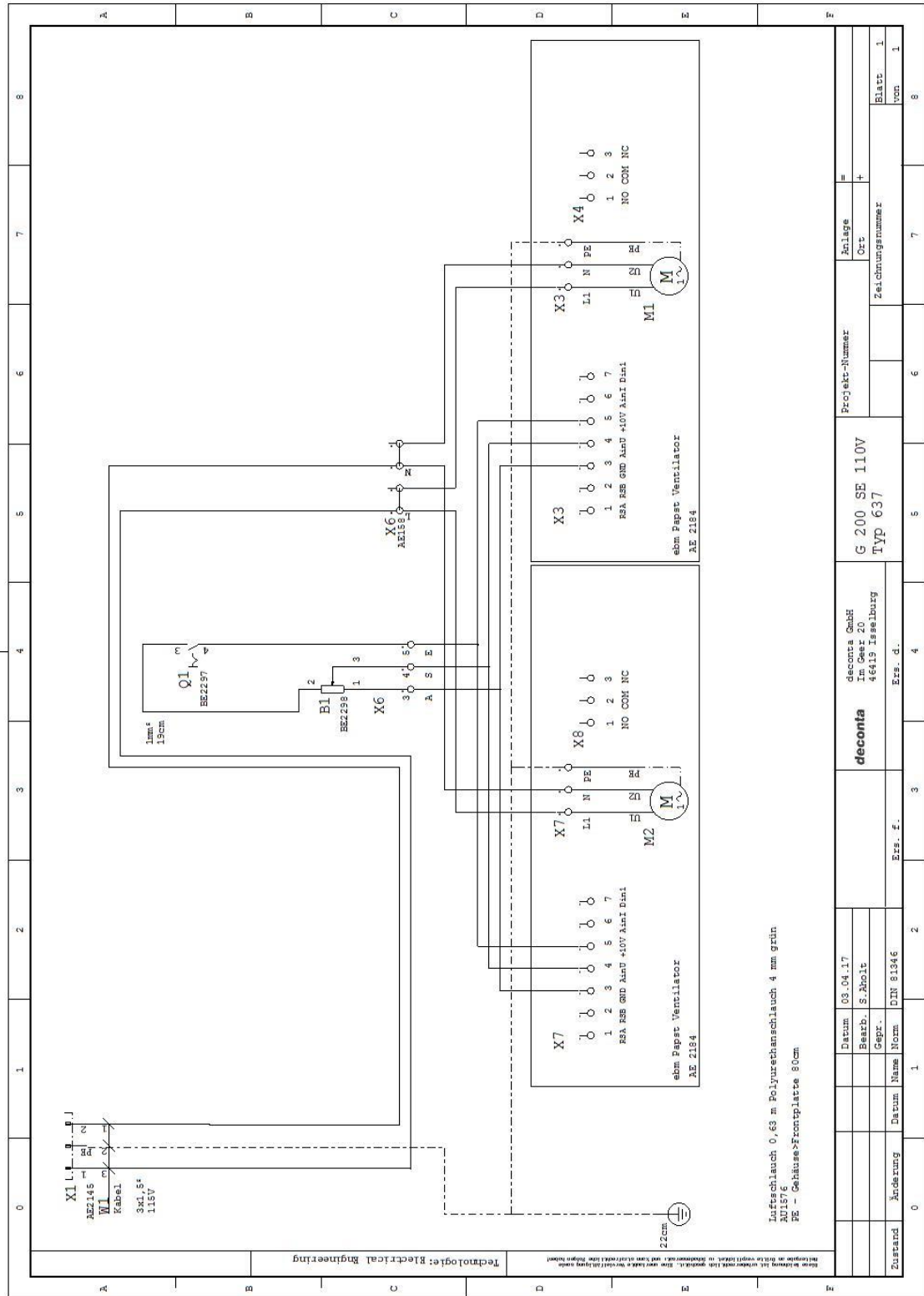

11.7 Negative pressure unit green dec G 200 SE, 230 volt version

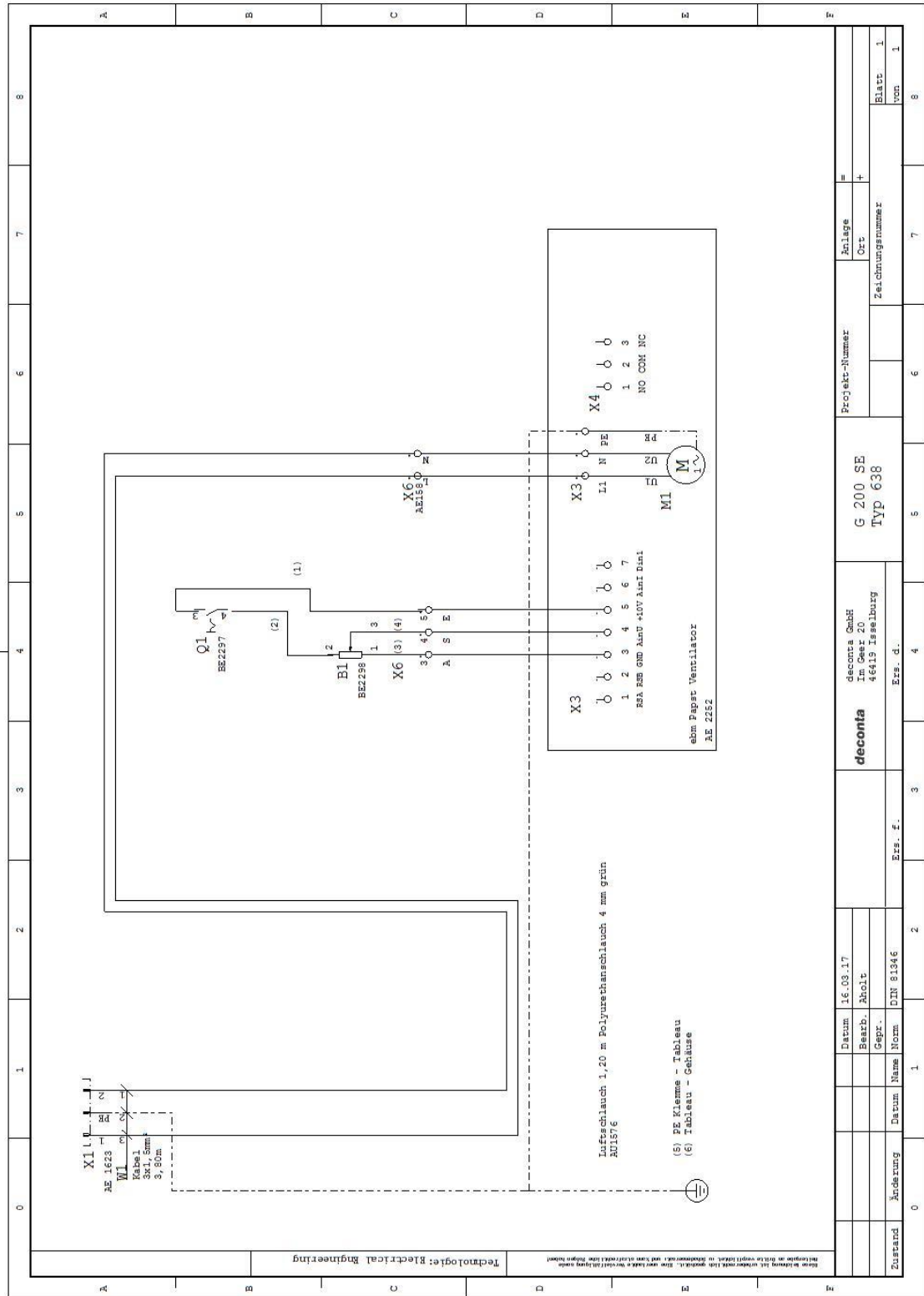



11.8 Negative pressure unit green dec G 200 SRE connect, 230 volt version

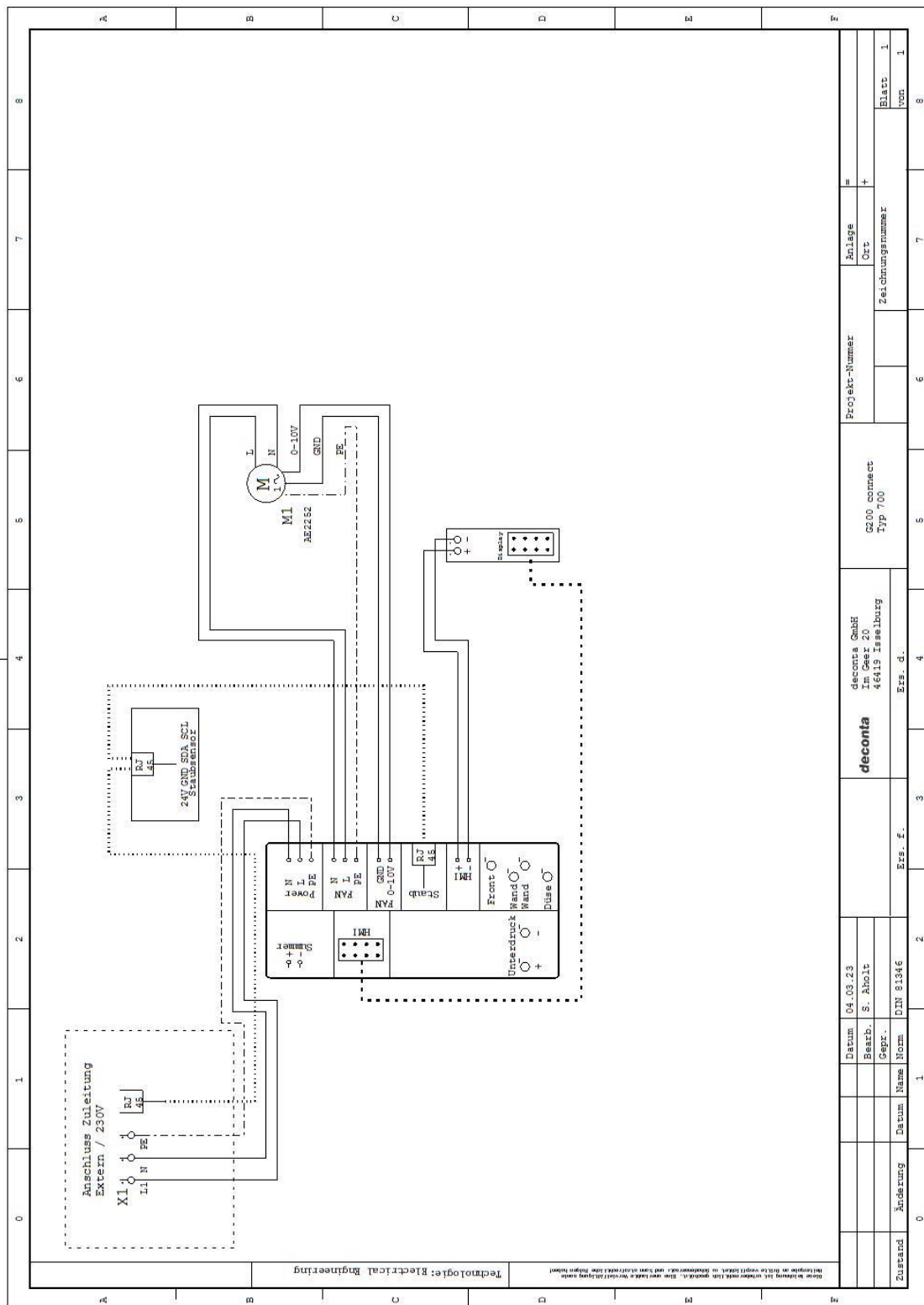

11.9 Negative pressure unit green dec G 300 SE, 110 volt version

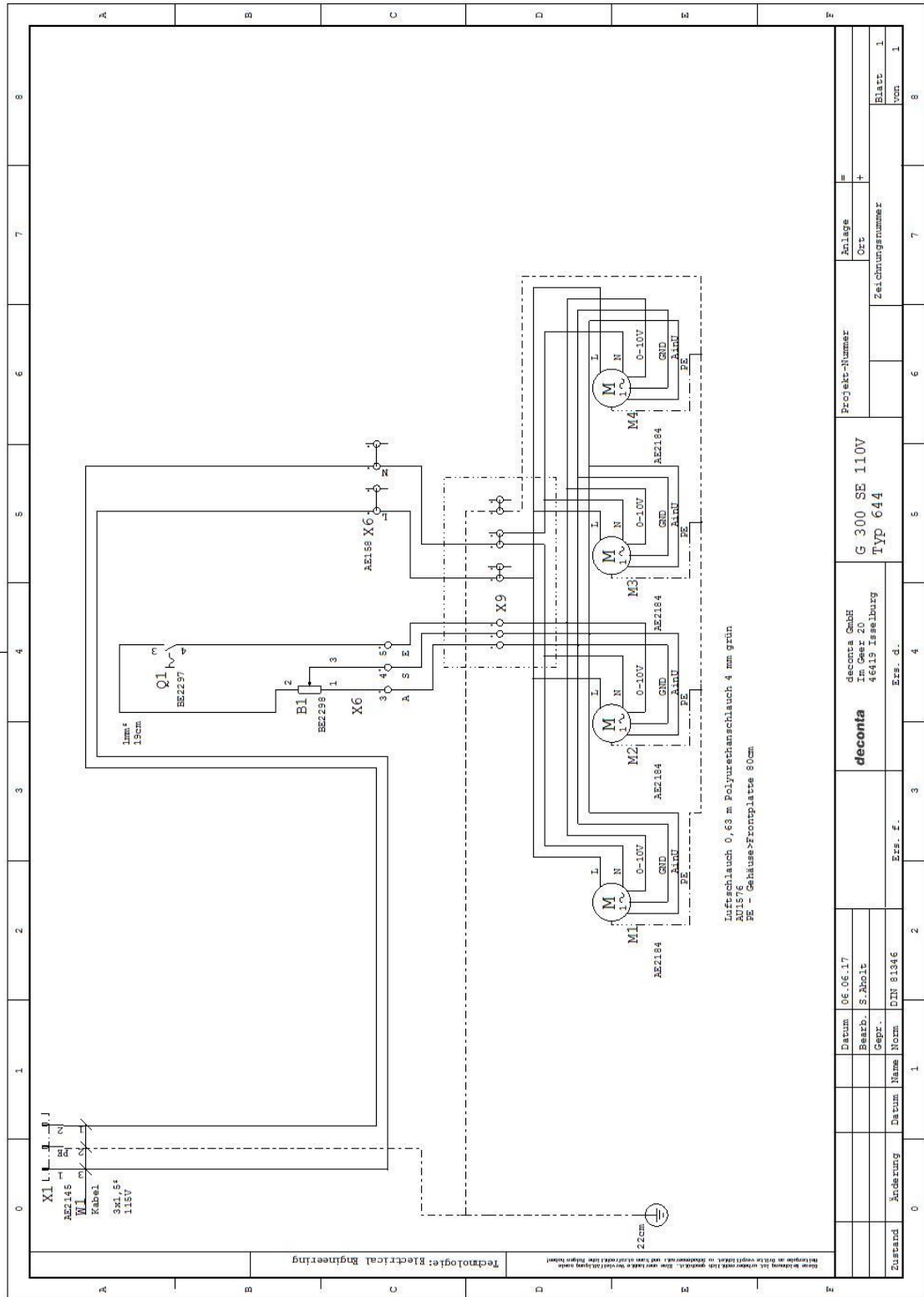

|         |  |          |  |       |  |           |  |          |  |         |  |                 |  |              |  |            |  |                |  |
|---------|--|----------|--|-------|--|-----------|--|----------|--|---------|--|-----------------|--|--------------|--|------------|--|----------------|--|
| Zustand |  | Änderung |  | Datum |  | Name      |  | Ers. f.  |  | Ers. d. |  | Projekto-Nummer |  | Anlage       |  | Ort        |  | Blatt          |  |
|         |  |          |  |       |  | DIN 81346 |  |          |  |         |  | G 300 SE 110V   |  | Typ 644      |  |            |  | von 1          |  |
|         |  |          |  |       |  | Norm      |  |          |  |         |  | deconta         |  | deconta GmbH |  | In Ges. ZD |  | 46415 Iseeburg |  |
|         |  |          |  |       |  | Datum     |  | 06.06.17 |  |         |  | Bearb.          |  | S. Abolt     |  |            |  |                |  |
|         |  |          |  |       |  | Gepr.     |  |          |  |         |  | Projekto-Nummer |  |              |  |            |  |                |  |

**11.10 Negative pressure unit green dec G 300 SE, 230 volt version**

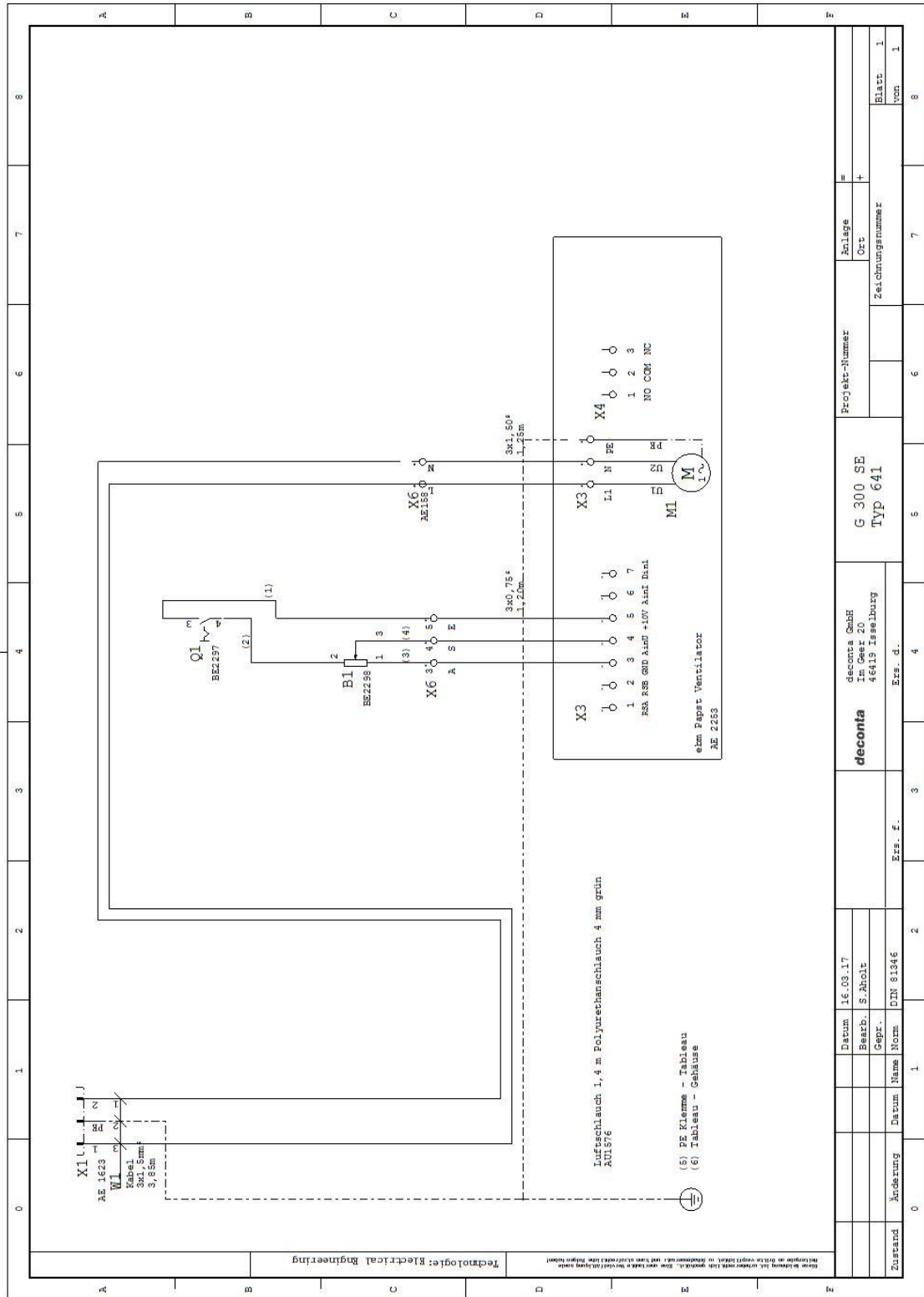

**11.11 Negative pressure unit green dec G 300 SRE connect, 230 volt version**

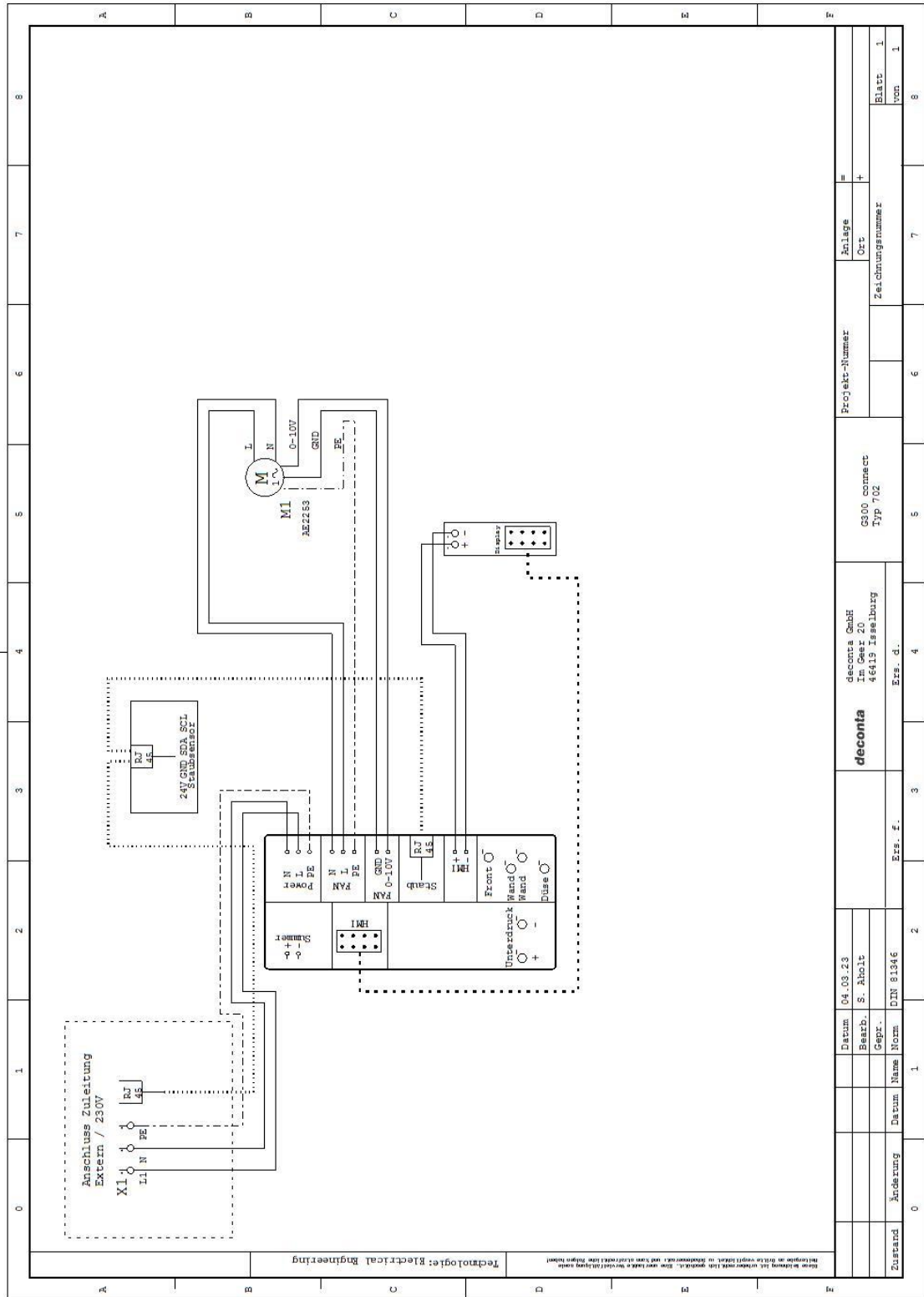

|         |  |          |  |          |  |          |  |           |  |         |  |         |  |                                               |  |                |  |               |  |                  |  |              |  |   |  |
|---------|--|----------|--|----------|--|----------|--|-----------|--|---------|--|---------|--|-----------------------------------------------|--|----------------|--|---------------|--|------------------|--|--------------|--|---|--|
| Zustand |  | Änderung |  | Datum    |  | Name     |  | Norm      |  | Ers. f. |  | Ers. d. |  | G300 connect<br>Typ 702                       |  | Projekt-Nummer |  | Anlage<br>Ort |  | Zeichnungsnummer |  | Blatt<br>von |  |   |  |
|         |  |          |  | 04.03.23 |  | S. Ahoit |  | DIN 81346 |  |         |  | Ers. d. |  | deconta GmbH<br>in Gear 20<br>46415 Isselburg |  | deconta        |  |               |  |                  |  | 1            |  | 8 |  |

**11.12 Negative pressure unit green dec G 400 SE, 230 volt version**

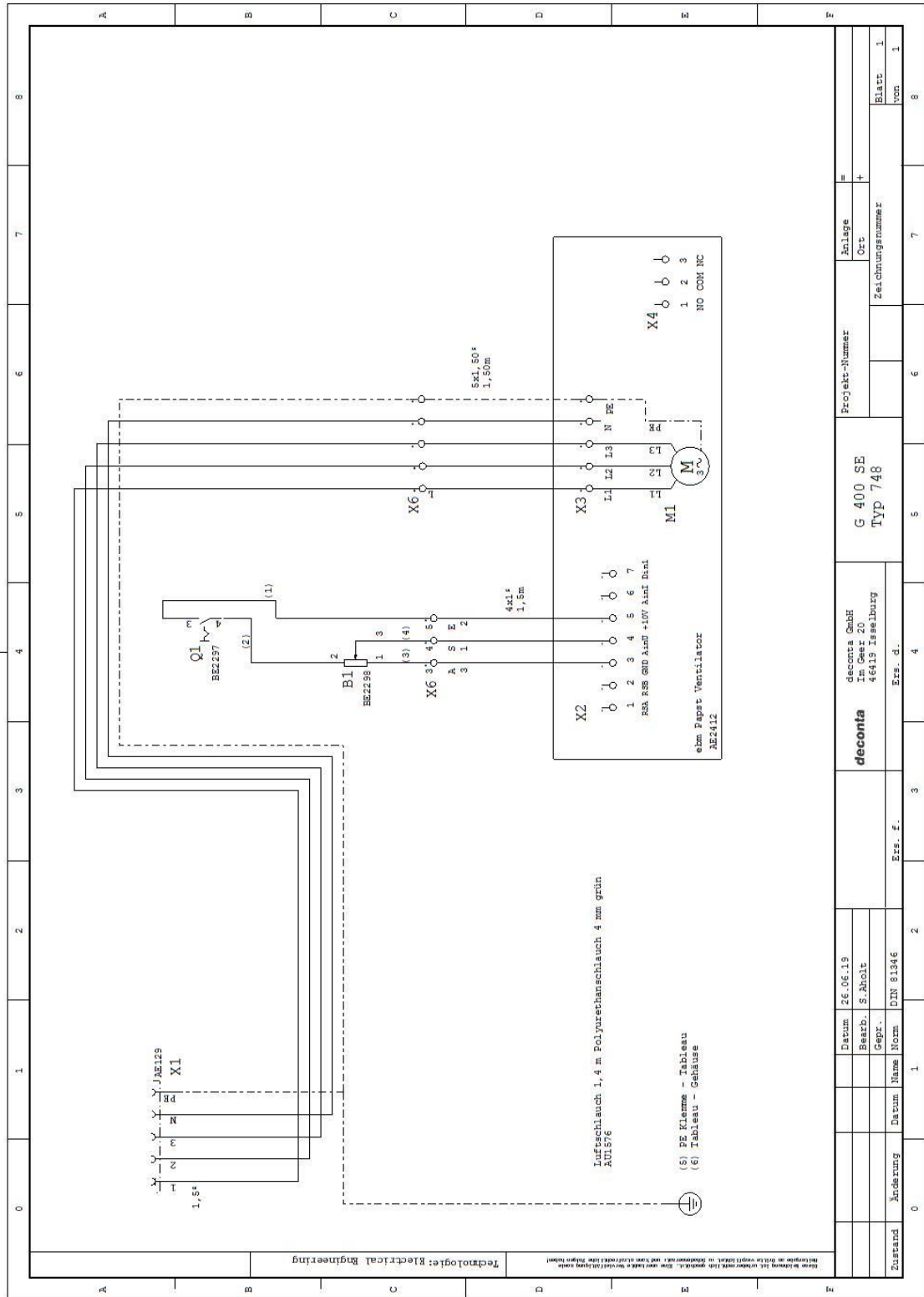

11.13 Negative pressure unit green dec G 400 SRE connect, 230 volt version

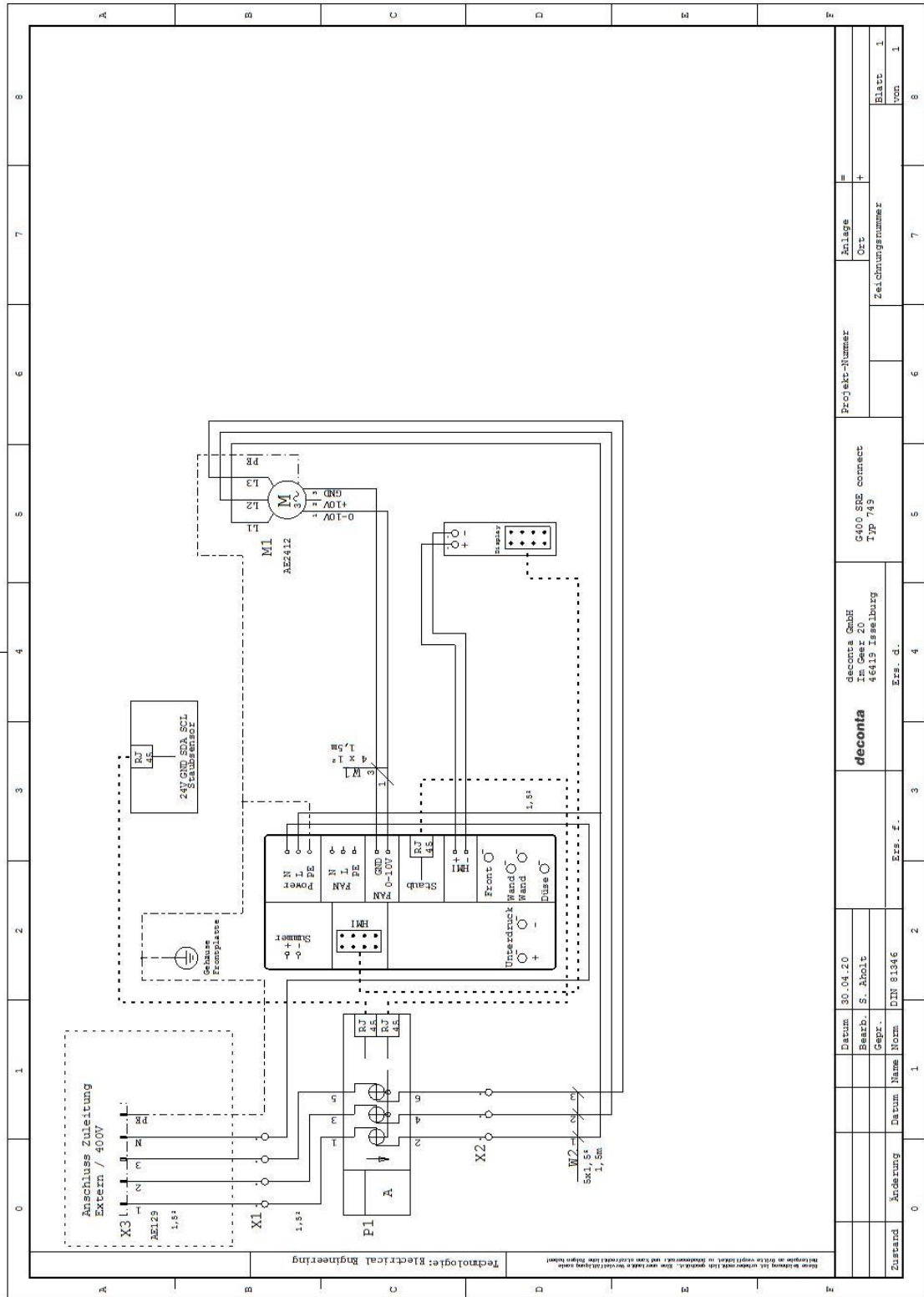

11.14 Negative pressure unit green dec G 500 SE, 230 volt version

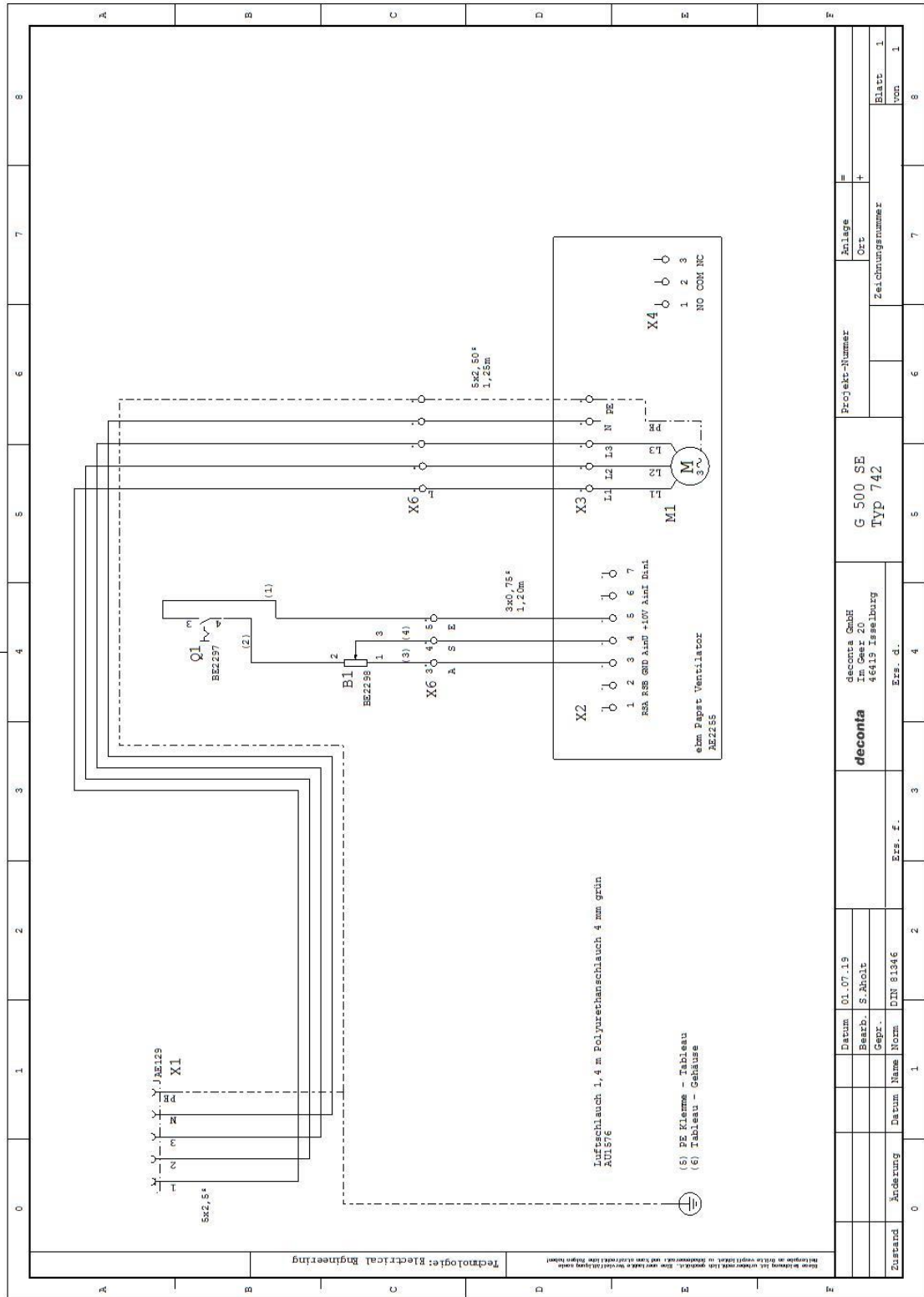

11.15 Negative pressure unit green dec G 500 SRE connect, 230 volt version

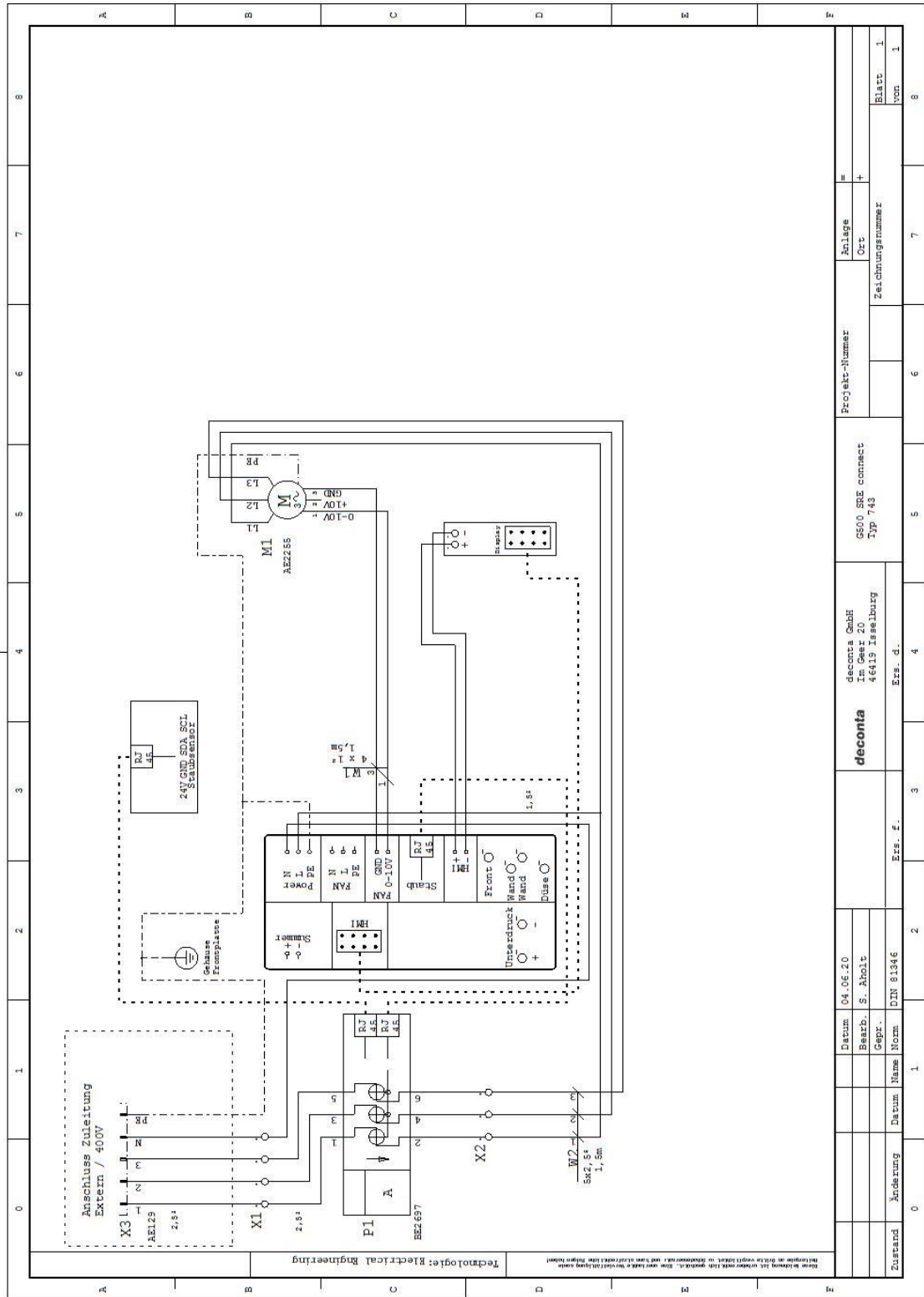



## 12 Storage

This section contains information on the safe storage of the machine.

The machine is stored in the following cases:

- After decommissioning for a longer period of non-use
- After a decommissioning for a site relocation

### 12.1 Environmental conditions

The machine can be stored under the following environmental conditions:

|                     |                     |
|---------------------|---------------------|
| Ambient temperature | 0 °C to +45 °C      |
| Relative humidity   | 70 % non-condensing |

### 12.2 Requirements

The following requirements must be met for storing the machine:

- Thoroughly cleaned (decontaminated)
- with mounted transport / closing lid

**We expressly refer to possible additional regional and national regulations when storing the appliance technology.**

## 13 Disposal

Disposal is the capturing, collecting, forming, selecting, processing, regenerating, destroying, recycling and selling of the materials to be disposed of that are built into the machine.

This section contains information on the proper and professional disposal of the machine.

### 13.1 Qualification of the staff

Persons disposing of the machine must meet the following requirements:

| Person   | Required qualification                                                                                    |
|----------|-----------------------------------------------------------------------------------------------------------|
| Disposer | Qualified waste management company for legally compliant, proper and professional disposal of the machine |

### 13.2 Legislation

Disposal of the machine shall be in accordance with the legislation of the country where the machine is disposed of.

Compliance with these legal regulations is basically the responsibility of the operator of the machine or the person in charge of disposal.

### 13.3 Waste

The waste generated by the machine must be disposed of in a legally compliant, proper and professional manner.

## 14 EC Declaration of Conformity

The manufacturer / distributor

deconta GmbH  
Im Geer 20  
46419 Isselburg

hereby declares that the following product

Product name: green dec  
Type designation: G 50, G 100, G 200, G 300, G 400, G 500  
Serial number: see type plate  
Trade name: Negative pressure unit green dec  
Year of manufacture: see type plate  
Description: Negative pressure unit green dec

complies with all relevant provisions of the applied legal regulations (hereinafter) - including their amendments in force at the time of the declaration. The sole responsibility for issuing this declaration of conformity lies with the manufacturer. This declaration relates only to the machine in the condition in which it was placed on the market; parts and/or interventions subsequently fitted by the end user are not taken into account.

The following legislation was applied:

Machinery Directive 2006/42/EC  
EMC Directive 2014/30/EU  
Radio Equipment Directive 2014/53/EU  
RoHS Directive 2011/65/EU

The protection goals of the following further legal regulations were complied with:

Low Voltage Directive 2014/35/EU

The following harmonised standards were applied:

|                         |                                                                                                                                 |
|-------------------------|---------------------------------------------------------------------------------------------------------------------------------|
| EN 60204-1:2018         | Safety of machinery - Electrical equipment of machines - Part 1: General requirements (IEC 60204-1:2016 (Modified))             |
| EN 61000-6-2:2005       | Electromagnetic compatibility (EMC) - Part 6-2: Generic standards - Immunity for industrial environments (IEC 61000-6-2:2005)   |
| EN 62368-1:2014/AC:2015 | Equipment for audio/video, information and communication technology - Part 1: Safety requirements (IEC 62368-1:2014 (Modified)) |
| EN ISO 12100:2010       | Safety of machinery - General principles for design - Risk assessment and risk reduction (ISO 12100:2010)                       |
| EN ISO 13849-1:2015     | Safety of machinery - Safety-related parts of control systems - Part 1: General principles for design (ISO 13849-1:2015)        |
| EN ISO 13849-2:2012     | Safety of machinery - Safety-related parts of control systems - Part 2: Validation (ISO 13849-2:2012)                           |
| EN ISO 13857:2019       | Safety of machinery - Safety distances to prevent hazard zones from being reached by the upper and lower limbs (ISO 13857:2019) |

Name and address of the person authorised to compile the technical file:

Boland, Thomas - deconta GmbH - Im Geer 20 - 46419 Isselburg

Place: Isselburg

Date: 23.02.2023

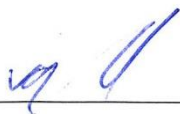

Leiter Konstruktion / head of construction



Leiter Elektro / head of electro